

# MODEL 630 TYPE 5 VOLT-OHM-MILLIAMMETER



**TRIPLETT  
CORPORATION**

*One Triplet Drive  
Bluffton, Ohio 45817*

## **SAFETY RULES**

### **Warning**

This tester has been designed with your safety in mind. However, no design can completely protect against incorrect use. Electrical circuits can be dangerous and/or lethal when lack of caution or poor safety practices are used.

### **Read The Manual**

Read this Instruction Manual carefully and completely.

Voltages and currents within the capability of this test equipment can be hazardous. Follow the instructions in this manual for every measurement. Read and understand the general instructions before attempting to use this tester. Do not exceed the limits of the tester.

### **Safety Check**

Double check the switch setting and lead connections before making measurements. Are you following all of the instructions?

Disconnect the tester or turn off the power before changing switch positions.

Do not connect to circuits with voltage present when switch is in any ohms or current position.

When replacing fuses use only specified type fuses and insert in correct fuse holder.

### **Don't Touch**

Don't touch exposed wiring, connections or other "live" parts of an electrical circuit. If in doubt, check the circuit first for voltage before touching it.

Turn off the power to a circuit before connecting test probes to it. Be sure there is no voltage present before you touch the circuit.

Do not use cracked or broken test leads.

### **High Voltage Is Dangerous**

Always start with the power off. Be sure there is no voltage present before making connections to the circuit.

Don't touch the tester, its test leads, or any part of the circuit while it is on.

Before disconnecting the tester, turn the circuit off and wait for the meter to return to "zero."

### **Distribution Circuits Pack A Punch**

In high energy circuits such as distribution transformers and bus bars, dangerous arcs of explosive nature can occur if the circuit is shorted. If the tester is connected across a high energy circuit when set to a low resistance range, a current range, or any other low impedance range, the circuit is virtually shorted.

Special equipment designed for use with these circuits is available. Contact a qualified person for assistance before attempting to make measurements on any high energy circuit.

### **Safety Is No Accident**

# TABLE OF CONTENTS

## Model 630

Safety Rules .....	2
Specifications .....	4
Introduction.....	6
Care Of Your VOM.....	7
General Instructions.....	8
Measuring DC Volts.....	14
Measuring AC Volts.....	15
Measuring DC Current .....	16
Measuring Resistance .....	17
Measuring Output Voltage.....	18
Measuring Decibels (dB).....	19
Maintenance .....	22
Accessories .....	25
Replaceable Parts .....	28
Schematic.....	30
Parts Location .....	31
Limited Warranty.....	32

## SPECIFICATIONS

### DC Volts

Ranges	0-0.3, 3, 12, 60, 300, 600
Accuracy	$\pm 1 \frac{1}{2}\%$ of Full Scale Reading (Calibrated at 77°F (25°C))
Sensitivity	20,000 Ohms per Volt; 16,667 Ohms per Volt on the 0-0.3 Volt Range
Maximum Input Voltage	600 Volts

### AC Volts

Ranges	0-3, 12, 60, 300, 600
Accuracy	$\pm 3\%$ of Full Scale Reading (Calibrated at 77°F (25°C))
Sensitivity	5,000 Ohms per Volt
Maximum Input Voltage	600 Volts RMS

### DC Current

Ranges	0-0.06 mA at 300 mV 0-1.2 mA at 250 mV 0-12 mA at 250 mV 0-120 mA at 290 mV
Accuracy	$\pm 1 \frac{1}{2}\%$ of Full Scale Reading

### Ohms

Ranges	0-1K, 10k, 100k, 1 Meg., 100 Meg. (4.4, 44, 4400, 440,000 at Center Scale)				
Accuracy	$\pm 1 \frac{1}{2}\%$ of Scale Length				
Maximum Voltage - Volts	X1	X10	X100	X1K	X100K
Maximum Current - mA	1.7	1.7	1.7	1.7	35.7
Maximum Power Transfer to Load - mW	386	38.6	3.86	386 $\mu$ A	81.1 $\mu$ A
	164	16.4	1.64	164 $\mu$ W	724 $\mu$ W



## SPECIFICATIONS (Continued)

Decibels (dBm) (1 mW, 600 $\Omega$ Line)	-20 to +11, -8 to +23, +6 to +37, +20 to +51, +26 to +57.
Scale	4.23 Inches Long (max.) Mirror Scale
Batteries	One 1.5 volt (D size) and one 30 volt battery. Batteries are packed separately.
Test Leads	One red and one black lead supplied, each 48 inches long. Two insulator type alligator clips included.
Size	7 1/2" high x 5 7/8" wide x 2 1/4" deep (19 cm x 15 cm x 5.7 cm).
Weight	3 1/4 pounds (1 1/2 kilograms) with batteries and test leads.
Temperature Influence	The meter movement has a temperature coefficient of less than $\pm 0.1^\circ/\text{C}$ without any special com- pensation devices. Resistors have a temperature coefficient of less than $\pm 150 \text{ PPM}/^\circ\text{C}$ . This allows a temperature influence of less than $+0.025\%/^\circ\text{C}$ on the resistance ranges and all DC voltage ranges except the 0.3 volt range.

## INTRODUCTION

Your VOM is a compact, rugged, portable volt-ohm-milliammeter. It has been designed to make fast, accurate measurements on all types of electrical and electronic equipment and is backed by a company which has been making quality instruments and test equipment for over half a century.

The indicating portion of the VOM is actuated by the latest concept in instrumentation, namely, a taut band suspension meter (shown below) having a sensitivity of 50 microampere full scale. This meter, by omitting conventional pivots, bearings and hairsprings provides the following advantages.

1. Increased repeatability by elimination of friction between pivots and bearings.

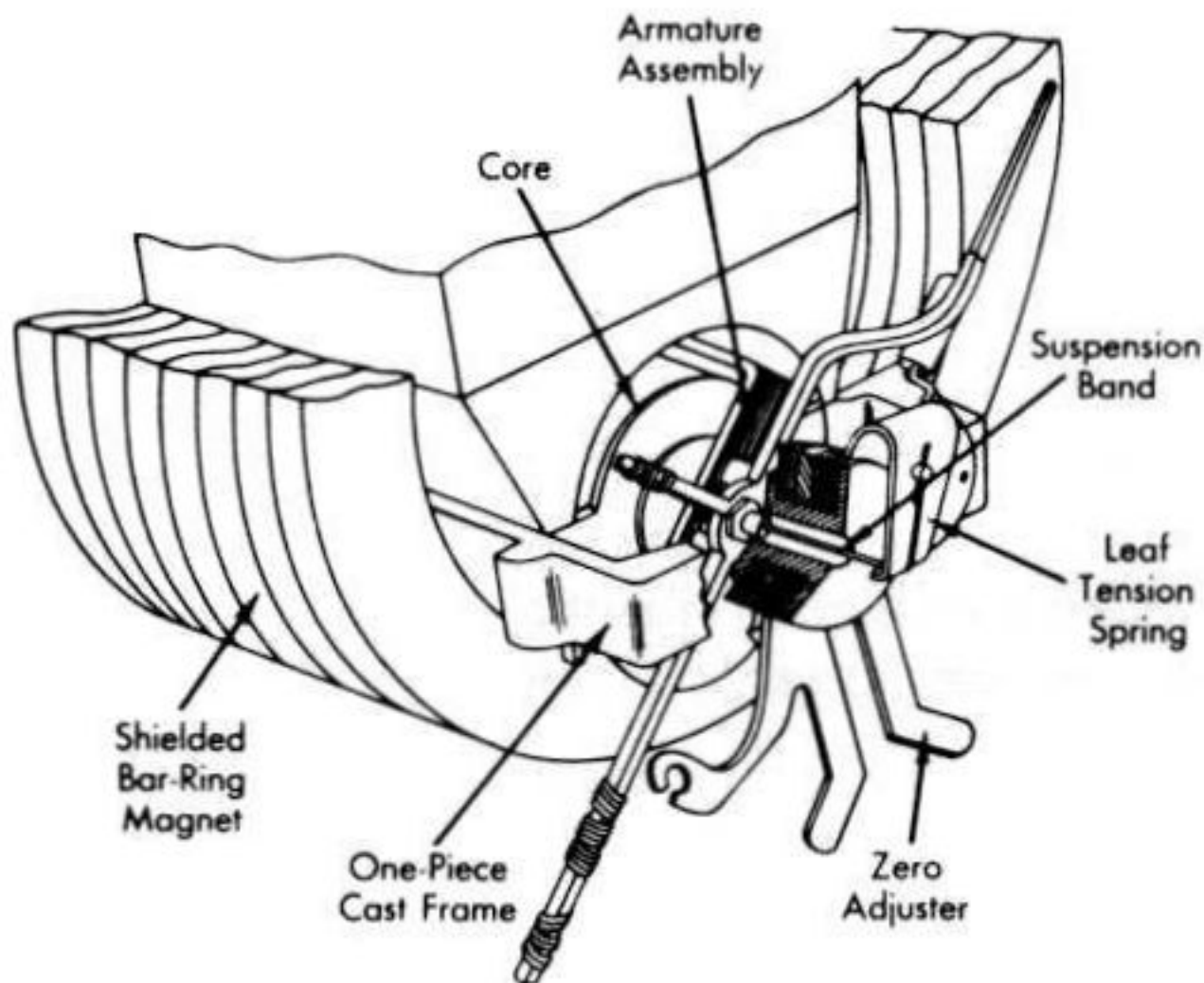

## **INTRODUCTION (Continued)**

2. Greater ruggedness and durability as no moving parts are in contact and the elimination of the hairspring prevents snagging and tangling. The tension spring acts as a built-in shock absorber.
3. Temperature variations can not cause sticky operation of the pointer.

Reference to the illustration will assist in understanding the principle of operation. The moving coil floats in the magnet by virtue of the suspension bands which are held in tension by a spring. These bands, which are fabricated of a precious metal alloy, provide torque and carry the current to the moving coil. The moving coil assembly is held by a rigid one piece die cast frame in a large self-shielded "Bar Ring" magnet.

## **CARE OF YOUR VOM**

- Although this instrument is portable and rugged it should be treated with care. Do not drop or handle it roughly.
- Avoid placing it on a bench where machine tools are used or severe vibration is encountered.
- When possible keep it in a place of moderate temperature. Avoid subjecting it to extreme temperatures and severe temperature changes.
- If the VOM has not been used for a long period of time, rotate the selector switch in both directions several times to wipe the switch contacts for good contact.
- Turn the selector switch to OFF when the VOM is to be carried. The meter is damped in the OFF position to prevent wild swinging of the pointer.

## **GENERAL INSTRUCTIONS**

**CONTROLS AND CONNECTIONS** - See below for the location of the controls and other important parts of the Triplet Model 630 V-O-M.

**DIAL** - The dial is the printed panel with graduated scales for indicating the measured quantity.

**SCALES** - Graduated arcs printed on the dial to indicate values of voltage, current, resistance or decibels.

**POINTER** - The pointer, sometimes called a needle, moves across the face of the dial to indicate the value of the measured quantity. The value is always read directly behind the pointer on the dial.

**ZERO ADJUSTER** - A control used to adjust the rest position of the pointer.

**OHMS ADJUST CONTROL** - A control used to recalibrate the resistance ranges when the battery voltage changes. In normal use, battery voltage drops and the OHMS ADJUST CONTROL is adjusted each time the resistance ranges are used.

— **JACK** - Negative connection for all DC measurements. This jack is connected to the negative terminal of the internal batteries on the resistance ranges.

**RANGE SWITCH** - Used to select the range of the V-O-M.

+ **JACK** - Positive connection for all DC measurements. This jack is connected to the positive terminal of the internal batteries on the resistance ranges.

**MIRROR** - The mirror is used to eliminate parallax errors. See Page 12



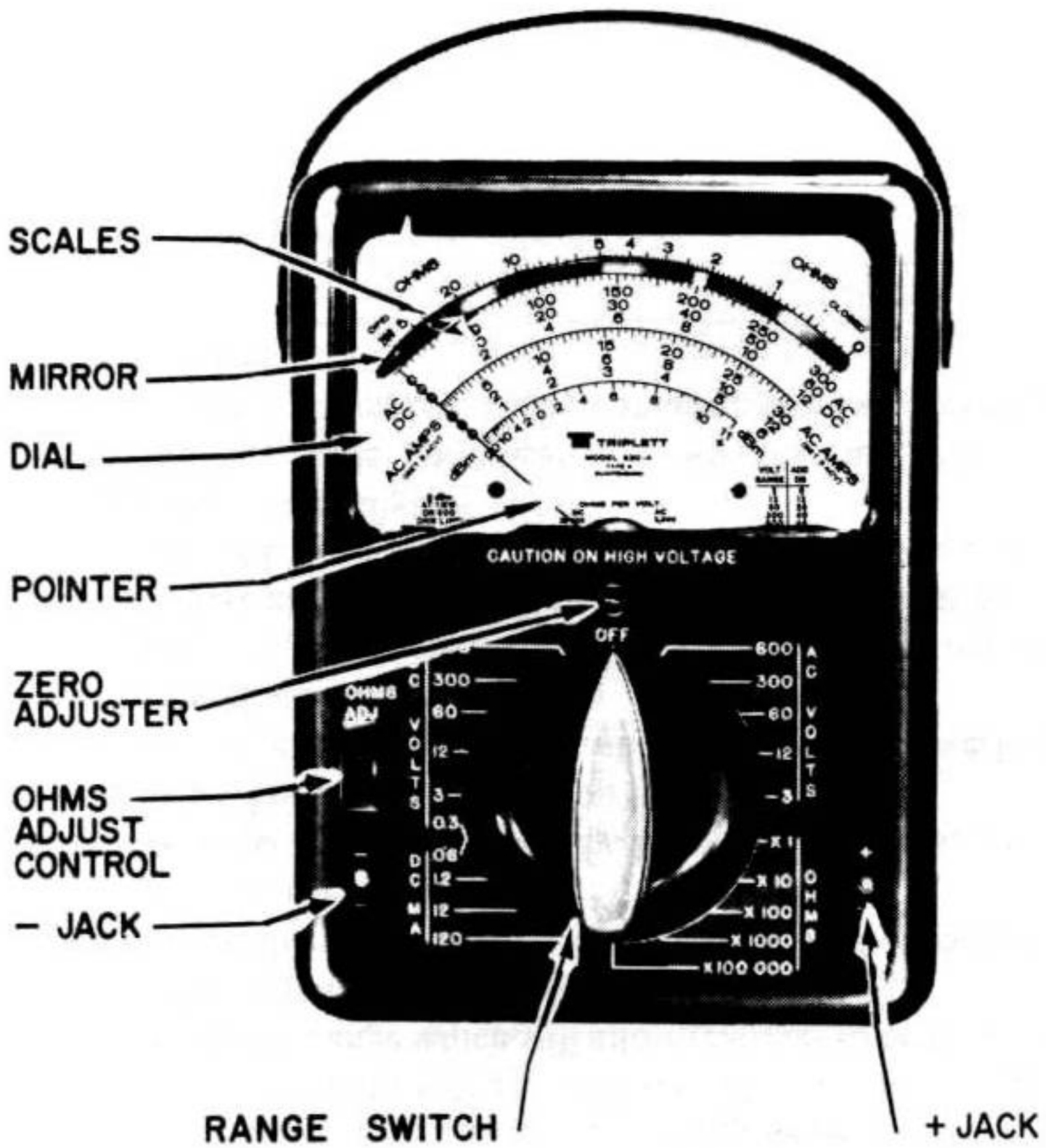

CONTROLS AND CONNECTIONS

## **GENERAL INSTRUCTIONS (Continued)**

### **GENERAL PROCEDURES**

Check the position of the pointer with nothing connected to the jacks. If necessary, adjust the pointer to rest over the left end of the scales (0) by turning the ZERO ADJUSTER.

Choose the range that gives the most pointer deflection without going beyond the end of the scales to get the most accurate measurement.

Do not change the range switch while the V-O-M is connected to a live circuit. Disconnect the V-O-M or turn off the circuit before changing ranges.

When the approximate value of the quantity being measured is not known, ALWAYS START ON THE HIGHEST RANGE. For greater accuracy, choose the range which will allow readings to be taken in the upper (right hand) portion of the scale.

Always check the range before connecting the probes to a circuit. It may be too late afterwards.

When working around potentially hazardous circuits, put one hand in your pocket and don't lean on anything.

Do not rotate the range switch when the tester is overloaded. Remove the overload first.

The alligator clips provided with the tester fit over the end of the test probes. These alligator clips allow measurement without handling the test probes. ALWAYS SHUT OFF THE POWER source before attempting to connect alligator clips.

Check the test leads periodically. Leads that are worn, have damaged insulation, damaged plugs, damaged probes or loose parts should be replaced.

## READING THE DIAL

The secret of accurate measurement is reading the dial properly. Table 1 shows the scales and numbers to use for each range.

**TABLE 1. READING THE DIAL**

RANGE	SCALE	NUMBERS
0.3 DC V	AC-DC	0-300 ( $\div$ 1000)
3 DC V	AC-DC	0-300 ( $\div$ 100)
12 DC V	AC-DC	0-12
60 DC V	AC-DC	0-60
300 DC V	AC-DC	0-300
600 DC V	AC-DC	0-60 (X 10)
3 AC V	AC AMPS	0-30 ( $\div$ 10)
12 AC V	AC-DC	0-12
60 AC V	AC-DC	0-60
300 AC V	AC-DC	0-300
600 AC V	AC-DC	0-60 (X 10)
0.06 DC mA	AC-DC	0-60 ( $\div$ 1000)
1.2 DC mA	AC-DC	0-12 ( $\div$ 10)
12 DC mA	AC-DC	0-12
120 DC mA	AC-DC	0-12 (X 10)
OHMS X 1	OHMS	0-1K
OHMS X 10	OHMS	0-1K (X 10)
OHMS X 100	OHMS	0-1K (X 100)
OHMS X 1000	OHMS	0-1K (X 1000)
OHMS X 100,000	OHMS	0-1K (X 100,000)
DECIBELS	dBm	See DECIBEL MEASUREMENTS



## **GENERAL INSTRUCTIONS (Cont.)**

### **PARALLAX CORRECTION**

One source of measurement error is looking at the dial at an angle. Because there is a space between the pointer and the dial, the apparent reading can be changed by moving your head from side to side. To prevent this parallax error, it is necessary to look at the dial from directly in front of the pointer.

The Triplett Model 630 has a mirror behind the dial to help eliminate parallax error. When reading the dial, line up the reflected image of the pointer directly behind the pointer. Then, without moving your head, read the dial.

### **HIDDEN ERRORS**

There are errors caused by the way a V-O-M is used that are not obvious. In these cases, the V-O-M will measure what is actually present accurately; however some external influence or the V-O-M itself will disturb the circuit enough to cause an incorrect measurement. Some precautions and sources of error are listed below.

Don't touch the test leads, circuit, or component being tested when measuring resistance. Body resistance and moisture can cause large errors.

Disconnect components from their circuit when measuring resistance to prevent other parts of the circuit from disturbing the measurement.

Turn off all electrical power and discharge capacitors before measuring resistance of electrical and electronic circuits to prevent errors and possible damage to the V-O-M.

In strong alternating current fields around large motors it may be



necessary to twist the test leads together to reduce the effect of these fields.

The overload protection circuit in the meter movement can act as a rectifier in strong RF fields and cause erratic meter indications. Provide adequate shielding and filtering of the V-O-M and test leads to reduce this problem.

When making current measurements, compensate for the voltage drop across the V-O-M in critical low voltage circuit measurements.

When making voltage measurements in high impedance electronic circuits, the current drawn by the V-O-M can change operating voltages while it is connected. The specifications section of this manual gives the V-O-M impedance for all ranges to assist in analyzing loading effect on the circuit.

Some troubleshooting procedures list voltage measurements that are made with a 20,000 ohm per volt V-O-M. The effect of circuit loading is already included in these values.

## **TYPICAL USES**

Some typical uses for a V-O-M include servicing electronic equipment, TV sets, electrical controls and electrical wiring circuits. A V-O-M is also useful for checking diodes and transistors. It can be used for automotive service. It can be used for power and RF measurements with the proper circuitry attached to it. Appliances, heating and air conditioning equipment are also serviced with a V-O-M. There are far too many special uses for a V-O-M to list them here; however many books are available from electrical and electronic distributors, mail order suppliers, hobby stores and appliance manufacturers that describe special uses of a V-O-M.

## DC VOLTAGE MEASUREMENTS

1. Set the range switch to the desired DC VOLTS range.
2. Plug the test leads into the jacks.
3. Connect the test leads across the circuit to be measured.  
**OBSERVE ALL SAFETY PRECAUTIONS.**
4. Read the voltage value on the black AD-DC scale.

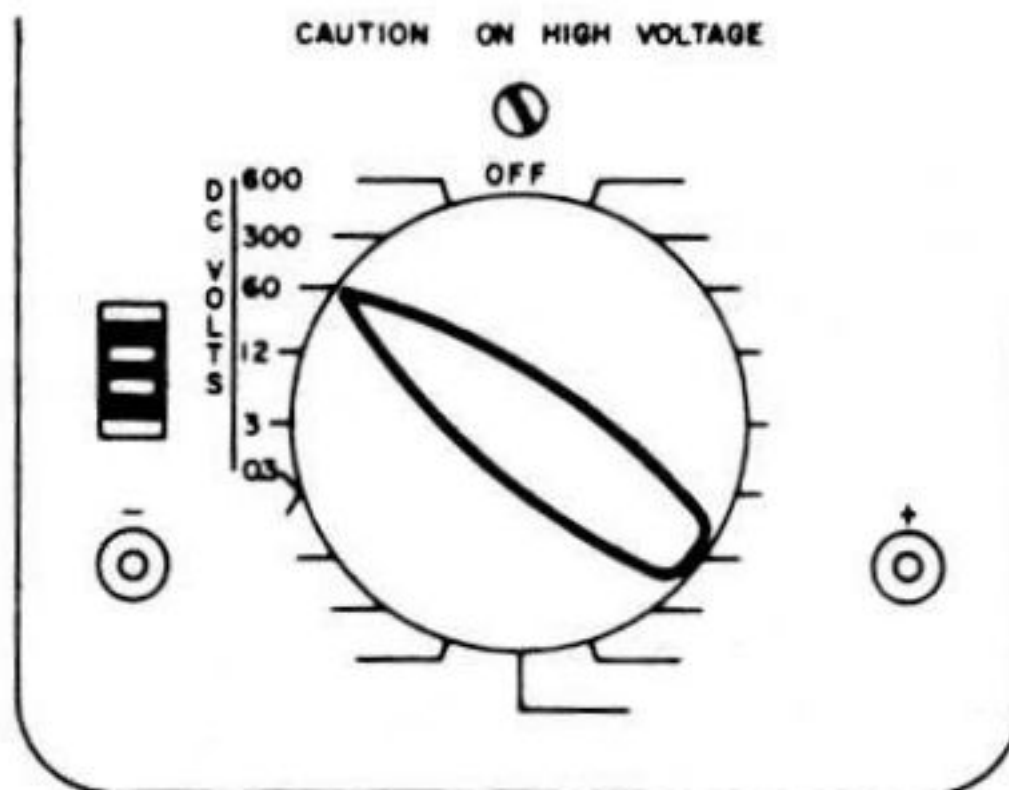

## DC VOLTAGE MEASUREMENTS

## AC VOLTAGE MEASUREMENTS

### 3 AC VOLTS RANGE

1. Set the range switch to the 3 AC VOLTS position.
2. Plug the test leads into the jacks.
3. Connect the test leads across the circuit to be measured. **OBSERVE ALL SAFETY PRECAUTIONS.**
4. Read voltage on the red 0-30 AC AMPS scale and divide the indication by 10.

### 12 AC VOLTS RANGE AND ABOVE

1. Set the range switch to the desired AC VOLTS range.
2. Plug the test leads into the jacks.
3. Connect the test leads across the circuit to be measured. **OBSERVE ALL SAFETY PRECAUTIONS.**
4. Read voltage on the black AC-DC scale.

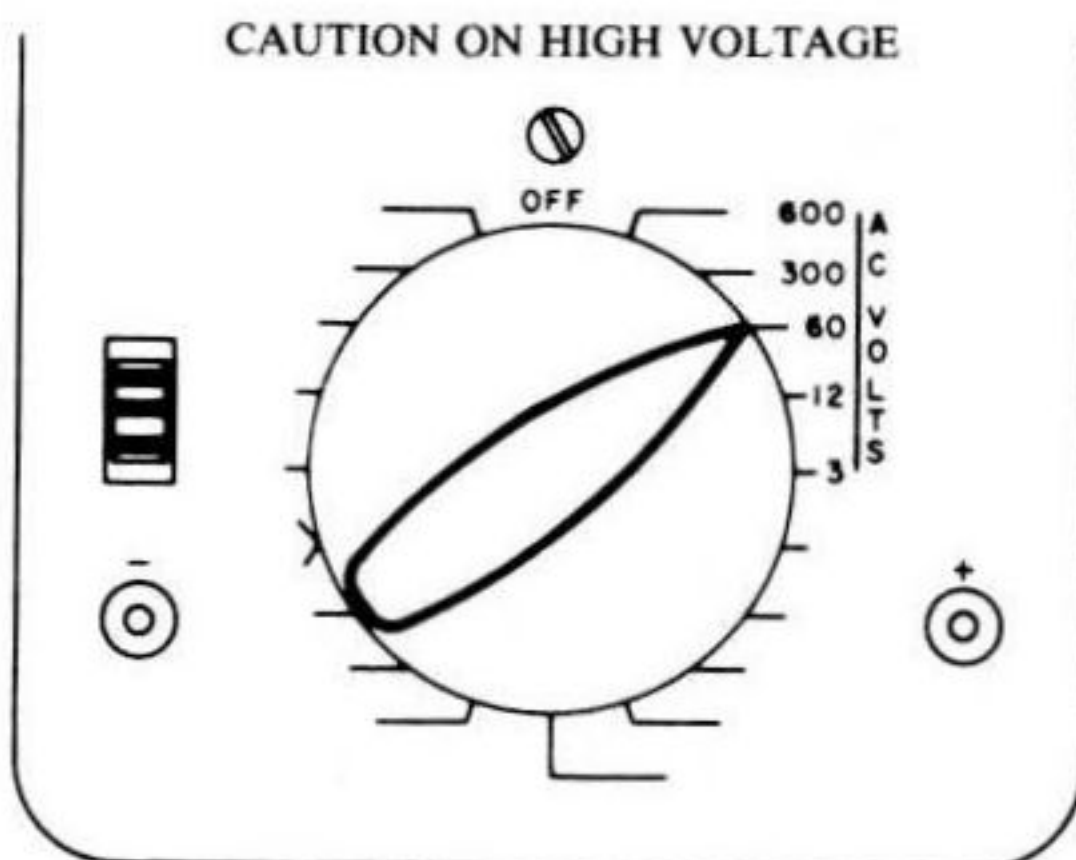

## AC VOLTAGE MEASUREMENTS

## DC CURRENT MEASUREMENTS

1. Set the range switch to the desired DC mA range.
2. Plug the test leads into the jacks.
3. Connect the test leads into the circuit to be measured.  
**OBSERVE ALL SAFETY PRECAUTIONS.**
4. Read the current value on the black AC-DC scale.

**CAUTION:** The circuit must be broken by unsoldering, cutting a wire, unscrewing a terminal or some other means. Be sure the power is **OFF** until the V-O-M is connected and ready for measurement.

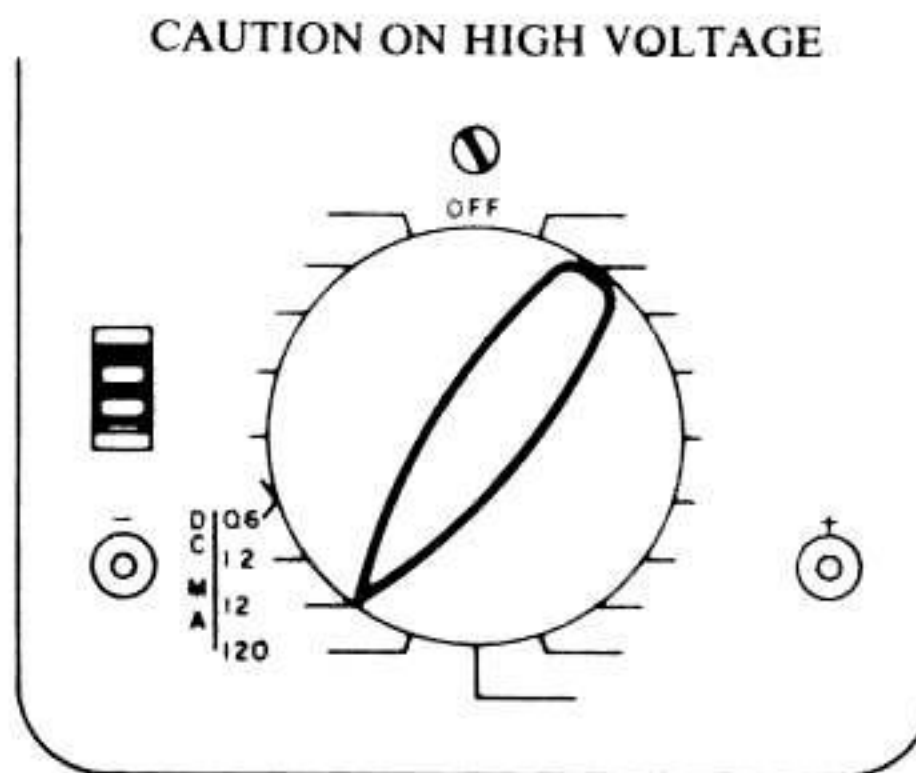

## DC CURRENT MEASUREMENTS



## RESISTANCE MEASUREMENTS

1. Set the range switch to the desired OHMS range.
2. Plug the test leads into the jacks.
3. Short the ends of the test leads together and adjust the OHMS ADJ control to set the pointer over the right end of the red OHMS scale (0 ohms).
4. Turn off all power to the circuit to be measured and discharge all capacitors.
5. If a single component in a circuit is to be measured, disconnect one lead from the circuit.
6. Connect the test leads to the circuit or component to be measured. **OBSERVE ALL SAFETY PRECAUTIONS.**
7. Read resistance on the red "OHMS" scale. **NOTE:** On the OHMS ranges, the + jack has the positive potential (it is connected to the + terminal of the battery).

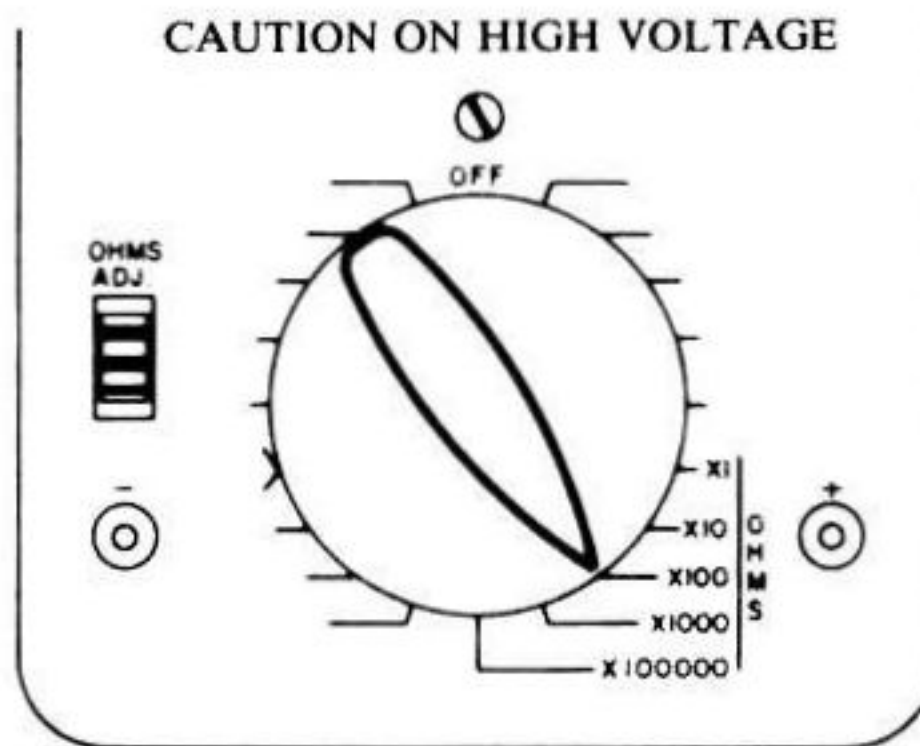

## RESISTANCE MEASUREMENTS

### CONTINUITY TESTING

For continuity testing, use the X1000 OHMS range. This gives longer battery life, reduces the chance of accidental damage to the V-O-M and reduces the chance of the V-O-M damaging the circuit.

## OUTPUT VOLTAGE MEASUREMENTS

Occasionally it is necessary to measure the AC part of a combined AC and DC voltage. The AC voltage ranges will respond to a DC input, too. It is necessary to put a DC blocking capacitor in series with the V-O-M input terminals to "block" or eliminate the DC part of the voltage. When making OUTPUT VOLTAGE measurements, follow the instructions for AC VOLTAGE measurements, but connect one test lead to the circuit through a capacitor.

Capacitor value depends on the accuracy desired, the frequency range to be measured, and the voltage in the circuit. The voltage rating of the capacitor should be equal to or greater than the highest voltage that can be encountered in the circuit. The capacitance value should be as large as possible to reduce measurement errors, especially at low frequencies and low voltages. Figure 10 shows the influence of a  $.22 \mu\text{F}$  capacitor on measurements with the 3, 12, and 60 AC VOLTS ranges. The 300 and 600 AC VOLTS ranges are not effected significantly by a  $.22 \mu\text{F}$  capacitor.

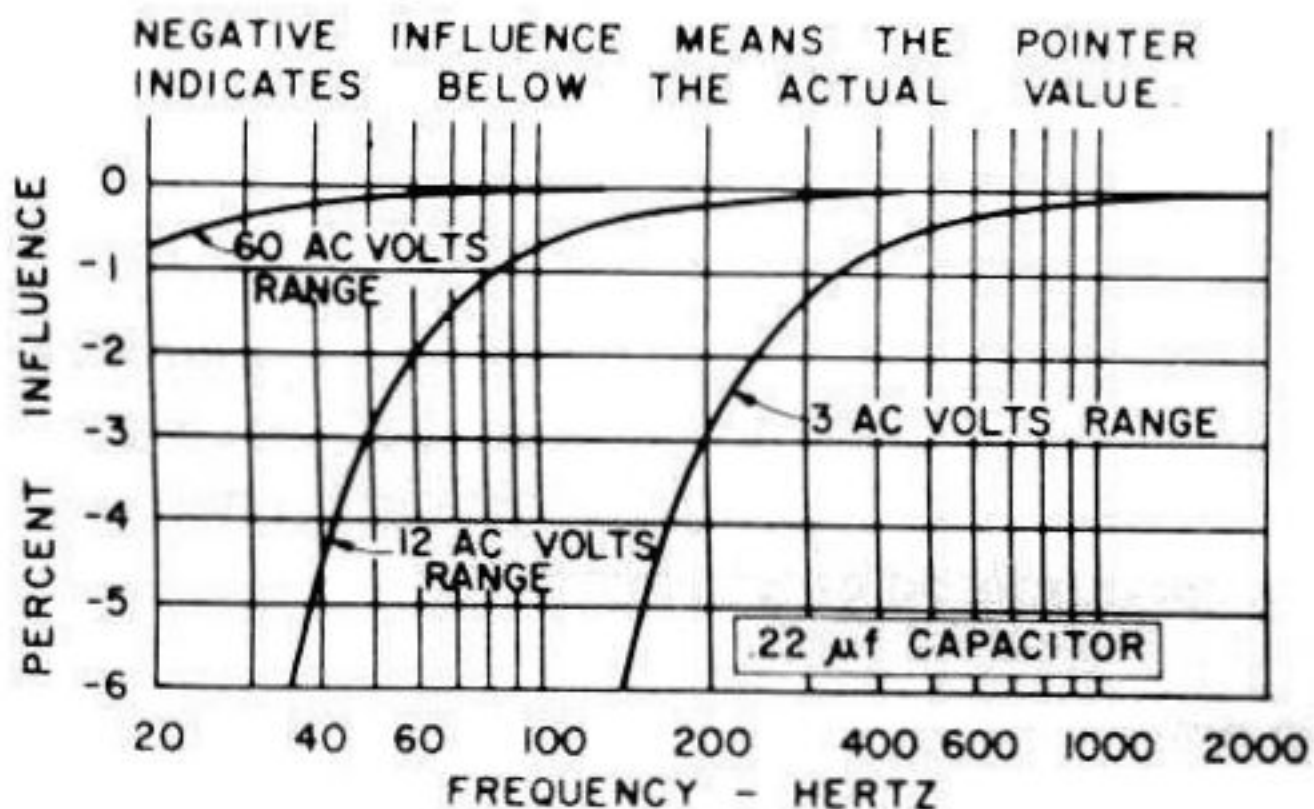

OUTPUT VOLTAGE FREQUENCY INFLUENCE

## DECIBEL MEASUREMENTS

Decibels are used in communications and other fields to specify relative power levels. The decibel approximates human hearing ratios and is mathematically derived to reduce multiplication and division to addition and subtraction.

All decibel measurements are based on a reference power level. The most common reference power level and the one used in this V-O-M is 1 milliwatt into a 600 ohm load. This means that 0 dBm represents 1 milliwatt into a 600 ohm load (.775 AC volts across a 600 ohm load).

To measure decibels, follow the instructions for AC VOLTAGE MEASUREMENTS or OUTPUT VOLTAGE MEASUREMENTS. Read the dBm scale on the dial and add the number of decibels specified for the range selected. Table 2 shows the switch positions, decibel ranges and number of decibels to be added. A table showing the number of decibels to add is shown on the V-O-M dial, too.

**TABLE 2 DECIBEL RANGES**

RANGE		SCALE	ADD TO READING
SWITCH	DECIBELS		
3 AC VOLTS	-20 to +11 dBm	dBm	0 dBm
12 AC VOLTS	- 8 to +23 dBm	dBm	12 dBm
60 AC VOLTS	+ 6 to +37 dBm	dBm	26 dBm
300 AC VOLTS	+20 to +51 dBm	dBm	40 dBm
600 AC VOLTS	+26 to +57 dBm	dBm	46 dBm

For accurate decibel measurements on the 12 AC VOLTS and higher ranges, a corrective factor may be needed. The decibel scale is made to track the 3 AC VOLTS range. Because of the rectifier circuit, the 3 AC VOLTS is not linear, but the 12 AC VOLTS and higher ranges are linear. This means that the decibel scale does not track the 12 AC VOLTS and higher ranges.



## DECIBEL MEASUREMENTS (Continued)

The figure below shows the correction factor to use on the 12 AC VOLTS and higher ranges. To apply the correction factor, proceed as follows:

1. Make the measurement as specified above.
2. Read the number of decibels indicated on the dial. (Don't add anything yet).
3. Find the correction factor for the number of decibels indicated on the dial.
4. Subtract the correction factor from the indicated number of decibels.
5. Add the number of decibels shown in Table 2 for the range selected.

It may not be necessary to use this correction if the value is in the upper 2/3 of the scale because the error is less than 1 dB. **DO NOT USE THIS CORRECTION ON THE 3 AC VOLTS RANGE.** The V-O-M indicates the correct value on the 3 AC VOLTS range.

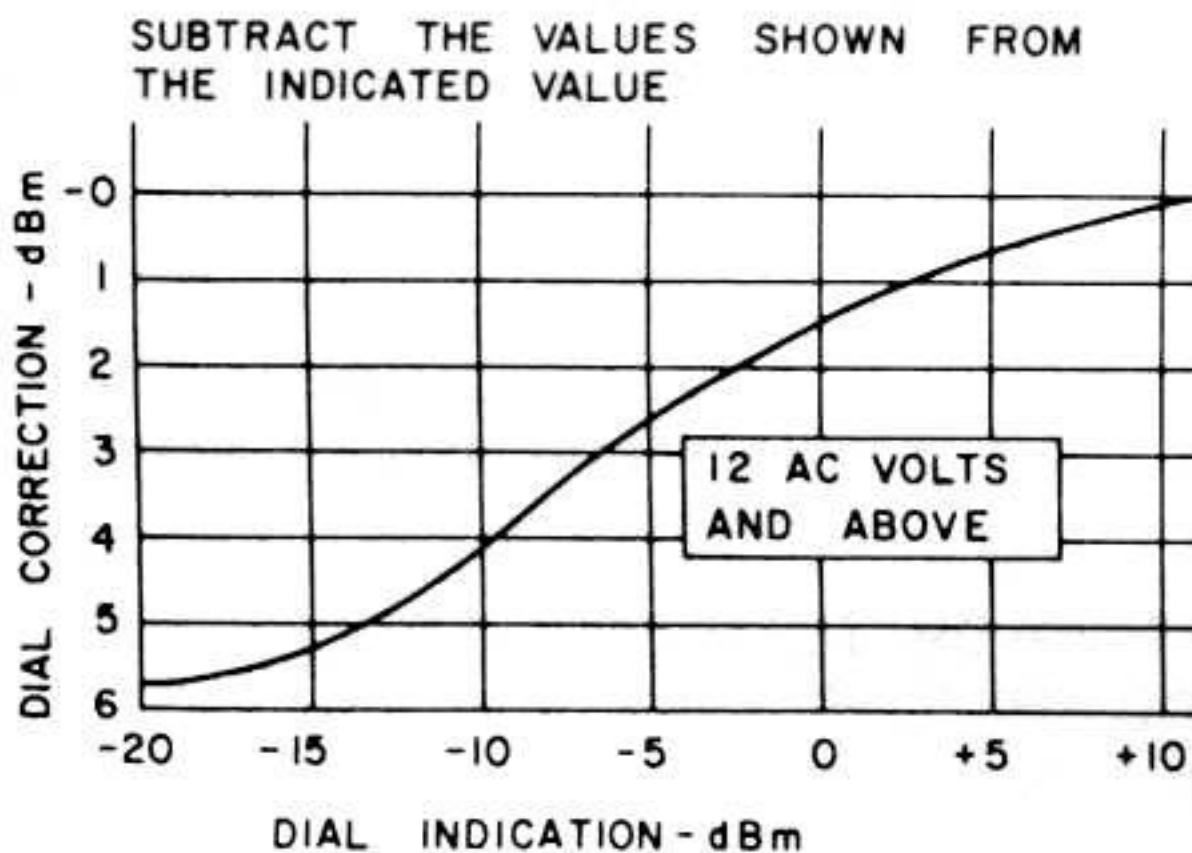

DECIBEL CORRECTION FACTOR



The Triplet Model 630 V-O-M measures decibels referenced to 1 milliwatt into a 600 ohm load. If the load or reference power level are changed, the measurements must be converted. Table 3 lists the conversion factors for some popular references for decibel measurements.

**TABLE 3    dB REFERENCE CONVERSION FACTORS**

0 dB REFERENCE	CONVERSION FACTOR
1 mW, 600 $\Omega$	None
6 mW, 600 $\Omega$	Subtract 7.8 dB from indication
6 mW, 500 $\Omega$	Subtract 7 dB from indication

## MAINTENANCE

### BATTERY REPLACEMENT

Batteries should be replaced whenever the OHMS ranges can't be adjusted to zero ohms. Check batteries for signs of corrosion or leakage occasionally.

To replace batteries:

1. Disconnect the test leads from external circuitry and remove them from the V-O-M jacks.
2. Remove the four screws at the corners on the back of the case.
3. Remove the case.
4. Remove the batteries from their holders and discard them.
5. Put new batteries in the battery holders. **OBSERVE PROPER POLARITY.** (See Figure below).
6. Replace the case and reinstall the screws.

Replacement batteries should be carbon-zinc dry cells, NEDA 13F "D" cell for the 1.5 volt battery and NEDA 210 for the 30 volt battery.

### BATTERY POLARITY

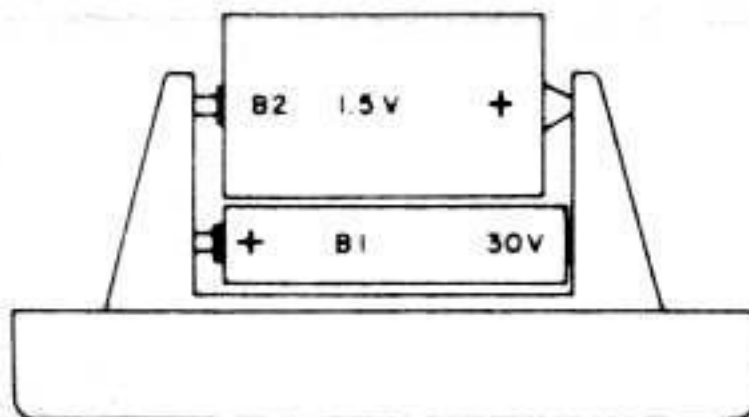

### FUSE REPLACEMENT

Replacement fuses must be:

Littelfuse 3AG 1 Amp or Bussmann BBS 2 Amp for the large fuse.

A spare 1 Amp fuse is located under the 30 volt battery.

To replace a fuse:

1. Disconnect the test leads from external circuitry and remove them from the V-O-M jacks.
2. Remove the four screws at the corners on the back of the case.
3. Remove the case.
4. Remove and discard the blown fuse.
5. Put a new fuse in the fuse holder. **USE ONLY THOSE SPECIFIED ABOVE.**
6. Replace the case and reinstall the screws.

## **CLEANING**

The outside of the V-O-M may be cleaned with a mild soap and water solution. Do not allow the soap and water to get inside the V-O-M.

## **CALIBRATION**

With normal use, readjustment of this V-O-M should not be necessary. Replacement parts are designed to be installed without any need for recalibration of the V-O-M. An occasional check of the V-O-M against a known reference voltage or another V-O-M is good practice. If there is a question about the accuracy of the V-O-M, it should be returned to the factory or an authorized service center for a calibration check.

## **PARTS REPLACEMENT**

Parts available for replacement are listed in the parts list. When replacing any parts, be careful to not disturb or damage any others. Do not overheat resistors or diodes, but be sure to make a good solder connection.

In some cases, it is wise to leave part of the lead from the old component and solder the new component to the old lead to prevent damage to surrounding components.

If there is evidence of smoke or an electrical arc inside the V-O-M, return the V-O-M to the factory or an authorized service center. There is a chance of hidden damage that could cause another failure of the V-O-M.

## MAINTENANCE (Continued)

### TROUBLESHOOTING GUIDE

SYMPTON	POSSIBLE CAUSES
V-O-M doesn't work on any range.	Blown fuse. Broken test lead.
V-O-M can't be adjusted for zero ohms on OHMS X1, X10, X100 and/or X1000 range.	B2 (1.5V) weak.
V-O-M can't be adjusted for zero ohms on OHMS X100,000 range.	B1 (30V) weak.
Pointer rests above or below zero without any input.	Meter movement needs to be rezeroed with the ZERO ADJUSTER.
V-O-M can't be adjusted for zero ohms on OHMS X1 range. All others OK.	B2 (1.5V) weak. Wrong fuse used for replacement. Fuse resistance too high.

For repair of this V-O-M, return it to the factory or an authorized service center. To help in repairing the V-O-M, give a detailed description of the problem and any other data that might be helpful such as what kind of circuit was being measured when the problem was discovered.

If the V-O-M is damaged by an overload and there is evidence of smoke or an electrical arc inside, return it to the factory or an authorized service center for inspection and repair. There could be some hidden damage that would cause a future failure of the V-O-M.



## ACCESSORIES

### ATTACHMENT LEAD

79-417

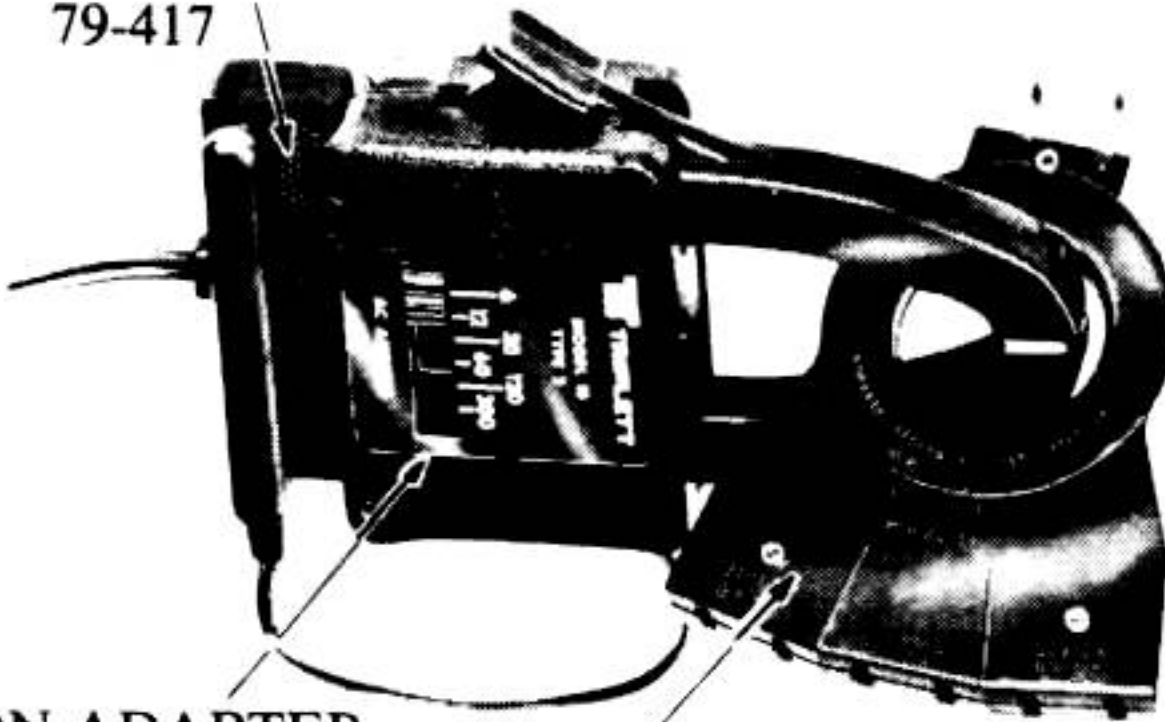

### CLAMP-ON ADAPTER

MODEL 10

60-211

### LINE SEPARATOR

MODEL 101

60-218

### MINIATURE CLIPS FOR HIGH DENSITY CIRCUITS

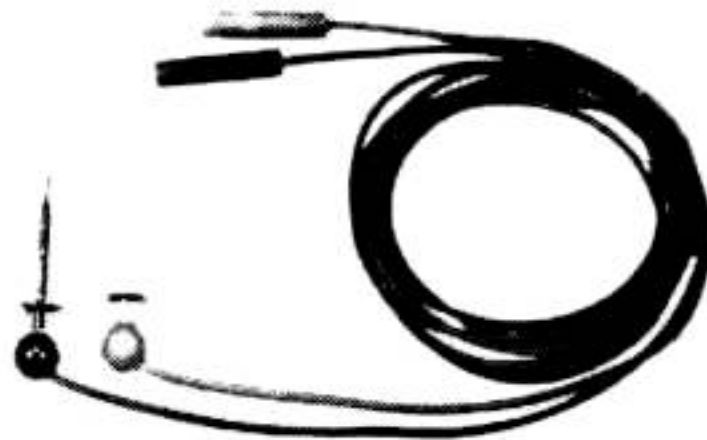

## HIGH VOLTAGE PROBES

Part No.	To Read	Set Range Switch	Read On Scale	Multiply By
79-397	30 kVDC	3 VDC	300 VDC	100
79-432	6 kVAC	3 VAC	60 AC-DC	100
79-433	6 kVDC	3 VDC	60 AC-DC	100



Carrying  
Case

## Model 639-OS

### Case 639-OS

Black quality man-made leather case, has built-in stand on back. Flaps open to permit use of tester in case. Compartment for accessories. For use with 630 series testers. Felt lined, strap handle.

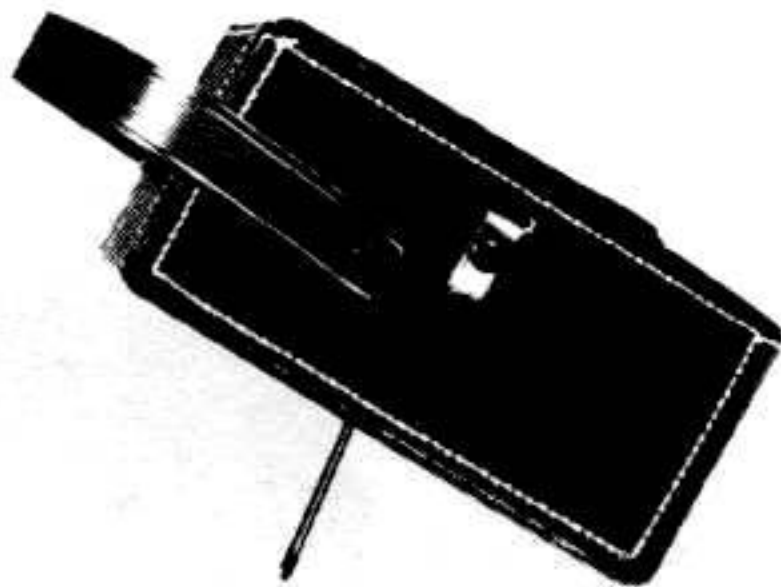

## Carrying Cases



Model 639-N

630-N black quality man-made leather carrying case. For use with 630 series testers. Stand available at extra cost. Strap handle.

Model 639 quality carrying case has adequate space for Triplet 630 series tester, instructions, and accessories. Black man-made leather, provided with strong quality strap handle.

Model 639-P is a quality carrying case padded with 3/8" sponge rubber which gives the instrument maximum protection. Has adequate space for any 630 series tester, instructions, and leads. Black man-made leather with strap handle.

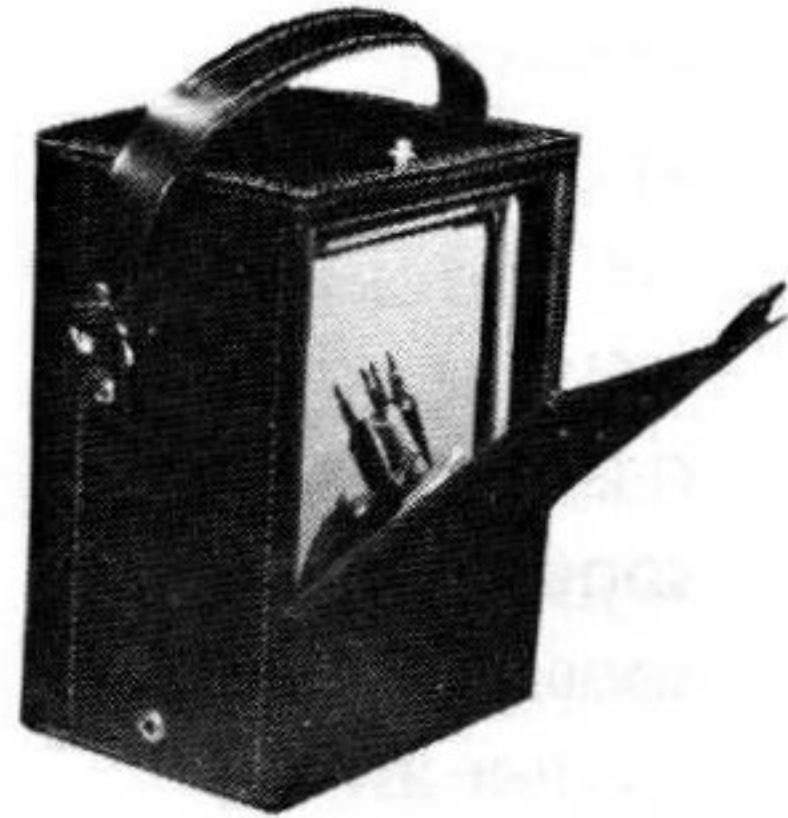

Rear view shows large accessory compartment permitting free access to tester stand, leads and instructions.

Model 639/639-P



## REPLACEABLE PARTS

Ref. No.	Description	Part No.
B1	Battery, 30V	37-19
B2	Battery, 1.5V "D"	2426-1
F1	Fuse, 2 Amp, 600V	3207-61
F2	Fuse, 1 Amp	3207-15
CRA1	Rectifier Assembly	2250-72
CRA2	Overload Protection Assembly	11670
M1	Meter with Front Panel Assembly	52-8588
R1	Resistor, 1.2 M $\Omega$	15K-1204TC5
R2	Resistor, 240 k $\Omega$	15K-2403TC5
R3	Resistor, 45 k $\Omega$	15K-4502TC5
R4	Resistor, 7.65 $\Omega$	15-5706
R5	Resistor, 3.55 $\Omega$	15-5708
R6	Resistor, 35.6 $\Omega$	15-5704
R7	Resistor, 365 $\Omega$	15K-3650UC5
R8	Resistor, 84.5 $\Omega$	15K-845FUC5
R9	Resistor, 4.66 k $\Omega$	15K-4661UC5
R10	Resistor, 845 $\Omega$	15K-8450UC5
R11	Resistor, 425 k $\Omega$	15K-4253UC5
R12		NOT USED
R13	Resistor, 2.084 $\Omega$	15-1558
R14	Resistor, 20.92 $\Omega$	15-2813
R15	Resistor, 217.4 $\Omega$	15-2288
R16	Resistor, 25 k $\Omega$	15K-2502UC5



## REPLACEABLE PARTS

Ref. No.	Description	Part No.
R17	Resistor, 833 $\Omega$	15K-8330UC5
R18	Resistor, 11.8 k $\Omega$	15K-1182UC5
R19	Resistor, 55 k $\Omega$	15K-5502UC5
R20	Resistor, 180 k $\Omega$	15K-1803UC5
R21	Resistor, 960 k $\Omega$	15K-9603UC5
R22	Resistor, 4.8 M $\Omega$	15-1542
R23	Resistor, 6 M $\Omega$	15-5711
R24	Resistor, 5 k $\Omega$	15K-5001TC5
R25	Resistor, 5 k $\Omega$	15K-5001TC5
R26	Resistor, 1.5 M $\Omega$	15K-1504TC5
R27	Resistor, 5.1 k $\Omega$	15R-512JC
R28	Resistor, 20 k Variable	16-31
	Switch with Components	22-707
	Knob	34-61
	Case with Handle	10-784
	Test Leads	79-374

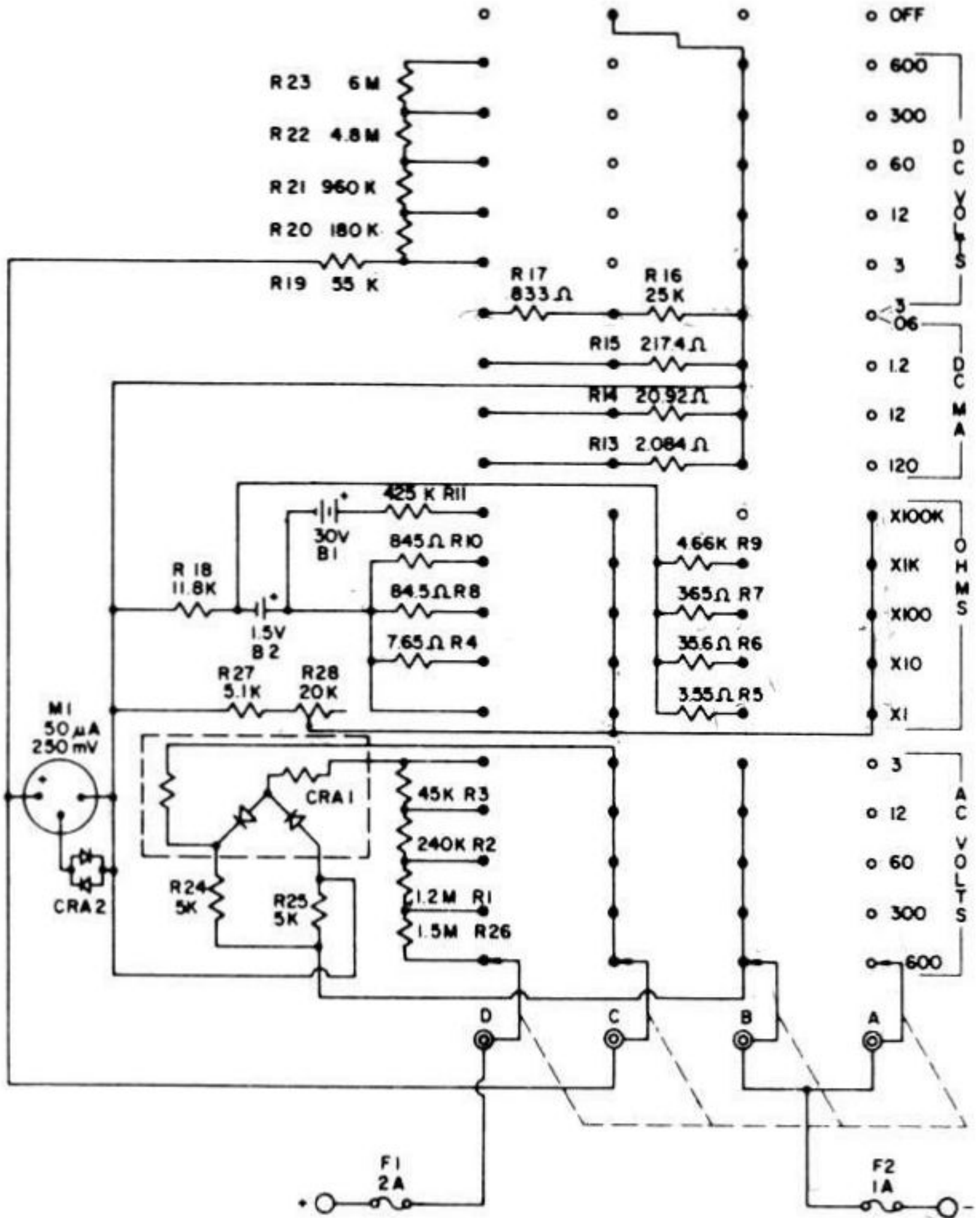

SCHMATIC

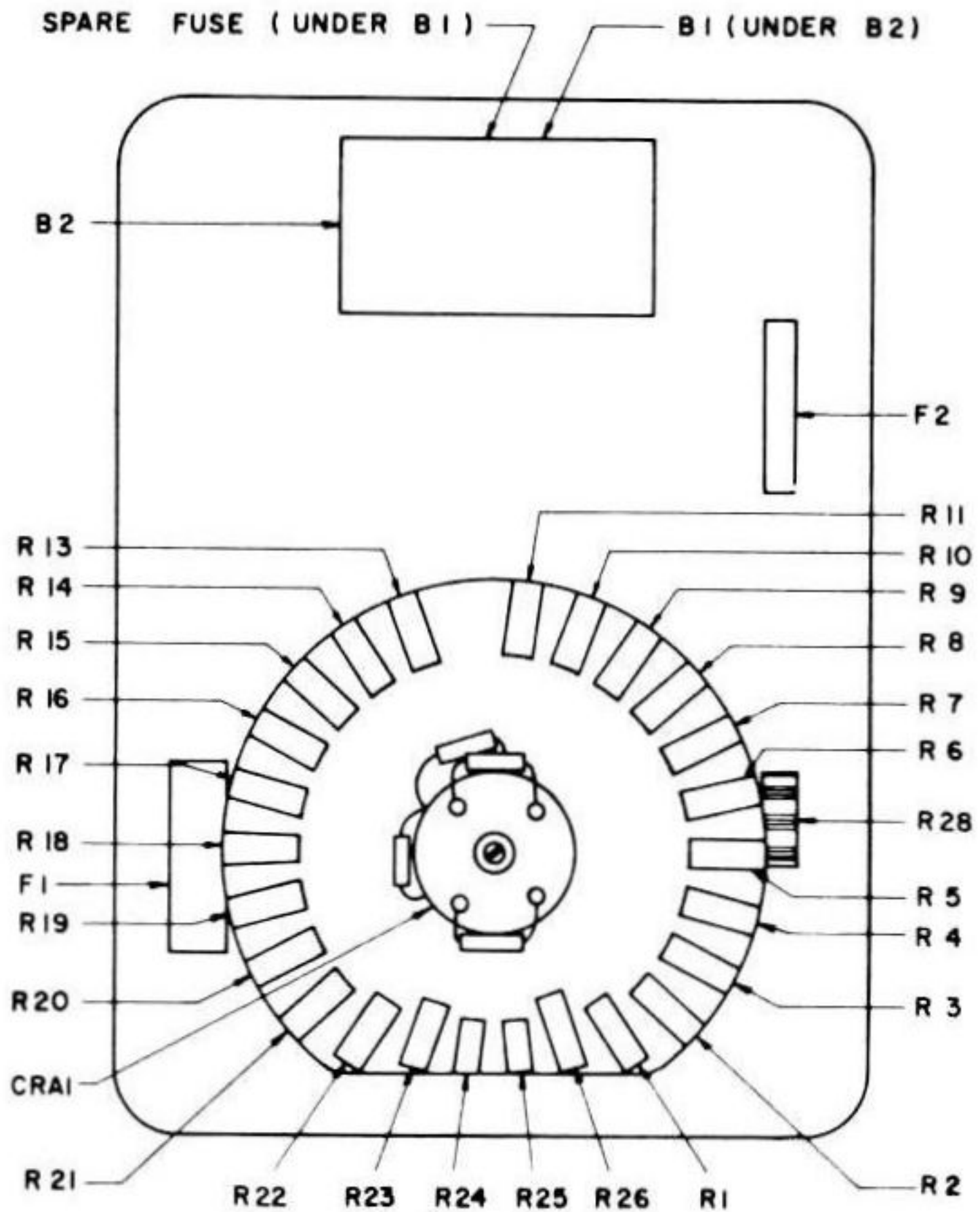

PARTS LOCATION

## **LIMITED WARRANTY**

The Triplett Corporation warrants instruments and test equipment manufactured by it to be free from defective material or factory workmanship and agrees to repair or replace such products which, under normal use and service, disclose the defect to be the fault of our manufacturing, with no charge for parts and service. If we are unable to repair or replace the product, we will make a refund of the purchase price. Consult the Instruction Manual for instructions regarding the proper use and servicing of instruments and test equipment. Our obligation under this warranty is limited to repairing, replacing or making refund on any instrument or test equipment which proves to be defective within three years (one year guaranteed calibration) from the date of original purchase.

This warranty does not apply to any of our products which have been repaired or altered by unauthorized persons in any way so as, in our sole judgment, to injure their stability or reliability, or which have been subject to misuse, abuse, misapplication, negligence or accident or which have had the serial numbers altered, defaced, or removed. Accessories, including batteries and fuses, not of our manufacture used with this product are not covered by this warranty.

To register a claim under the provisions of this warranty, return the instrument or test equipment to Triplett Corporation, Bluffton, Ohio 45817, transportation prepaid. Upon our inspection of the product, we will advise you as to the disposition of your claim.

**ALL WARRANTIES IMPLIED BY LAW ARE HEREBY LIMITED TO A PERIOD OF THREE YEARS, AND THE PROVISIONS OF THE WARRANTY ARE EXPRESSLY IN LIEU OF ANY OTHER WARRANTIES EXPRESSED OR IMPLIED.**

The purchaser agrees to assume all liability for any damages and bodily injury which may result from the use or misuse of the product by the purchaser, his employees, or others, and the remedies provided for in this warranty are expressly in lieu of any other liability Triplett Corporation may have, including incidental or consequential damages.

Some states (USA only) do not allow the exclusion or limitation of incidental or consequential damages, so the above limitation or exclusion may not apply to you. No representative of Triplett Corporation or any other person is authorized to extend the liability of Triplett Corporation in connection with the sale of its products beyond the terms hereof.

Triplett Corporation reserves the right to discontinue models at any time, or change specifications, price or design, without notice and without incurring any obligation.

This warranty gives you specific legal rights, and you may have other rights which vary from state to state.

**TRIPLETT CORPORATION**  
**Bluffton, Ohio 45817**