

## MODEL 3000 DIGITAL V-O-M

**TRIPLETT**  
**INSTRUCTION MANUAL**

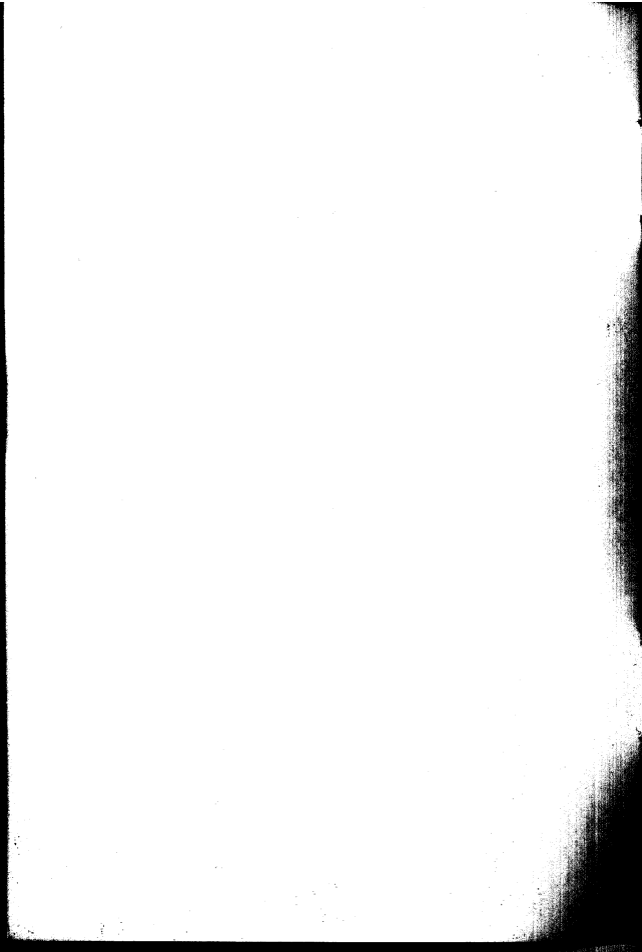



## WARNING

This tester has been designed with your safety in mind. However, no design can completely protect against incorrect use. Electrical circuits can be dangerous and/or lethal when lack of caution or poor safety practices are used.

## READ THE MANUAL

Read this Instruction Manual carefully and completely.

Voltages and currents within the capability of this test equipment can be hazardous. Follow the instructions in this manual for every measurement. Read and understand the general instructions before attempting to use this tester. Do not exceed the limits of the tester.

## SAFETY CHECK

Double check the switch setting and lead connections before making measurements. Are you following all of the instructions?

Disconnect the tester or turn off the power before changing switch positions.

Do not connect to circuits with voltage present when switch is in any ohms or current position.

When replacing fuses use only specified type fuses and insert in correct fuse holder.

### DON'T TOUCH

Don't touch exposed wiring, connections or other "live" parts of an electrical circuit. If in doubt, check the circuit first for voltage before touching it.

Turn off the power to a circuit before connecting test probes to it. Be sure there is no voltage present before you touch the circuit.

Do not use cracked or broken test leads.

### HIGH VOLTAGE IS DANGEROUS

Always start with the power off. Be sure there is no voltage present before making connections to the circuit.

Don't touch the tester, its test leads, or any part of the circuit while it is on.

Before disconnecting the tester, turn the circuit off and wait for the indication to return to "zero".

### DISTRIBUTION CIRCUITS PACK A PUNCH

In high energy circuits such as distribution transformers and bus bars, dangerous arcs of explosive nature can

## SAFETY RULES (cont'd.)

occur if the circuit is shorted. If the tester is connected across a high energy circuit when set to a low resistance range, a current range, or any other low impedance range, the circuit is virtually shorted.

Special equipment designed for use with these circuits is available. Contact a qualified person for assistance before attempting to make measurements on any high energy circuit.

SAFETY IS NO ACCIDENT

# TABLE OF CONTENTS

5

	Page No.
Description . . .	7
Specifications . . .	8
Nomenclature . . .	12
Preparation for Use . . .	14
Installation of Batteries . . .	15
General Instructions . . .	16
Operating Instructions . . .	19
Measuring AC or DC Volts . . .	22
Measuring Resistance . . .	24
Measuring Diodes . . .	26
Measuring AC or DC Current . . .	28
Maintenance and Calibration . . .	30
Performance Table . . .	32
Troubleshooting Procedure . . .	33
Disassembly Procedure for Calibration . . .	35
Exploded View . . .	37
Main Board, Parts Location . . .	38
Switch Board, Parts Location . . .	39
Replaceable Parts . . .	39
Schematic (Fold Out) . . .	43
Warranty . . .	44





## DESCRIPTION

The Triplett Model 3000 is a 3 1/2 Digit V-O-M, designed for general electrical and electronic troubleshooting and measurement. It has been especially designed to satisfy the need for a precision instrument in portable form. It can stand up under rigorous usage of the industrial and maintenance environment and at the same time provide a degree of safety in its use.

The Digital V-O-M is battery operated and employs rechargeable nickel cadmium batteries. It comes complete with a battery charger. The tester can be operated with or without the charger connected which gives the convenience of battery or an AC operated instrument.

The instrument is a five function V-O-M. It measures AC-DC Volts, AC-DC Current and Resistance for a total of 22 ranges.

## SPECIFICATIONS

## GENERAL

## Temp. Range

Operating - 0°C to 50°C.

Storage - -20°C to +65°C, without batteries installed.

Size - 5.39" L x 3.00" W x 1.38" T.

Weight - Approx. 10 ounces.

## Readout Display

3 1/2 Digit 1999 Counts.

.15" LED with Polarity Indication.

## Batteries

(4) Ni. Cad. 500 MAH.

## Charger

150 mA at 5.8V, (Cat. No. 12385).

## Fuses

1 Amp 250V Littelfuse 362001.

2 Amp 600V Bussmann BBS-2.

## DC VOLTS

## Ranges

.2, 2, 20, 200, 600 Volts.

## Accuracy

6 Months at 23°C ±5°C.

.2 Volt Range ±.25% of Rdg. ±2 Digits.

2, 20, 200, 600 Volts.

±.9% of Rdg. ±2 Digits.

- Polarity - Auto. - With Indication.  
T. C. - .02% of Rdg.  $\pm$ .01% FS/C $^{\circ}$ .  
Input Res. - 10 Meg.  
Step Response - 1 Sec. Typical.  
Sample Rate - 3-4/Sec.  
Input Bias Current - 4 PA Typical.  
CMRR - 90 dB Min. at 60 Hz.  
NMRR - 40 dB Min. at 60 Hz.  
Overload Protection - 0 to 600 Volts  
Max.

## AC VOLTS

### Ranges

.2, 2, 20, 200, 600 Volts.

### Accuracy

6 Months at 23 $^{\circ}$ C  $\pm$ 5 $^{\circ}$ C at 60 Hz.  
 $\pm$ 1.4% of Rdg.  $\pm$ 2 Digits.

T. C. -  $\pm$ .05%/C $^{\circ}$  of Rdg.  $\pm$ .025%/C $^{\circ}$   
of FS.

Average Detection - Calibrated in RMS  
on Sine Wave.

Input Resistance - 10 Meg., Cap 50 pF.

## SPECIFICATIONS (cont'd.)

Step Response - 3 Sec. Typical.

Overload Protection - 0 to 600 Volts  
Max.

DCV Superimposed on AC - 400 Volts  
Max.

## OHMS

	Ranges	Test Current	FS Voltage
Lo V	200 $\Omega$	1 mA	200 mV
Hi V	2K	1 mA	2 Volts
Lo V	20K	10 $\mu$ A	200 mV
Hi V	200K	10 $\mu$ A	2 Volts
Lo V	2M	.1 $\mu$ A	200 mV
Hi V	20M	.1 $\mu$ A	2 Volts

## Accuracy

6 Months at 23°C  $\pm$ 5°C.

200, 20K, 2M  $\pm$ .9% Rdg.  $\pm$ 2 Digits.

2K, 200K, and 20M  $\pm$ 1.4% Rdg.  $\pm$ 2  
Digits.

T. C. -  $\pm$ .05%/C° of Rdg.  $\pm$ .025%/C°  
of FS.

Step Response - 2 Sec. for all ranges  
except 20M range, 8 Sec. Typical.

Overload Protection - 0 to 600 Volts  
Max.

## AC-DC CURRENT

## Ranges

2, 20, 200 mA - .2 Volt Burden FS.

## Accuracy

6 Months at 23° C ±5° C.

## DC Current

±1.25% of Rdg. ±2 Digits.

## AC Current

50 to 10 kHz ±1.6% of Rdg.  
±2 Digits.

## T. C.

## DC Current

±.03%/C° of Rdg. ±.02%/C° of FS.

## AC Current

±.1%/C° of Rdg. ±.075%/C° of FS.

## Step Response

DC Current 1 Sec. Typical.

AC Current 3 Sec. Typical.

Overload Protection - Fuse Protected.

## Accessories

Carrying Case 10-2860

Battery Pack with

Ni. Cad. Batteries 10-2861

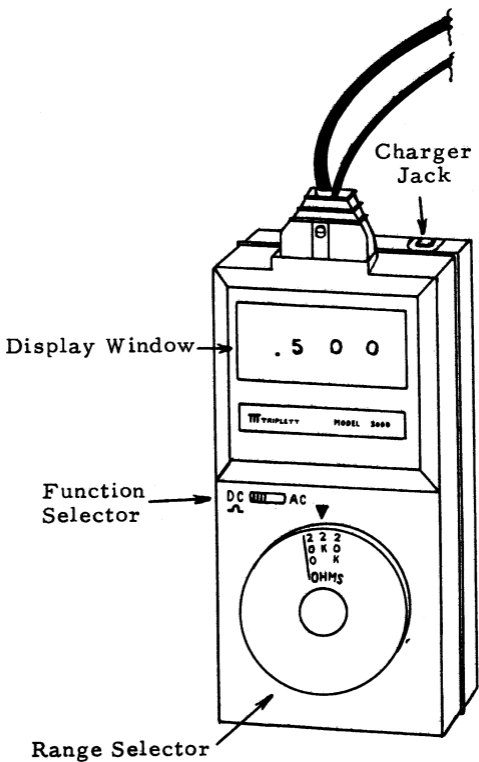
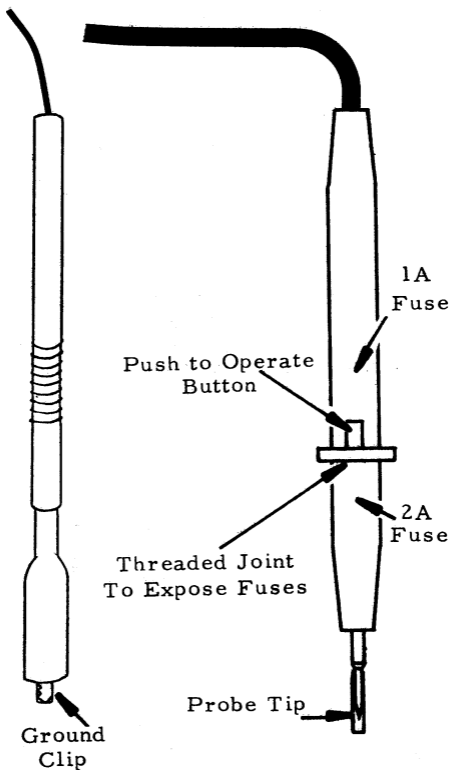

Fig. 1



## PREPARATION FOR USE

The tester is normally shipped with batteries in a discharged condition. The batteries should be charged before use or operated with charger connected. See page 20.

**CAUTION:** In emergency, carbon or alkaline batteries may be installed for temporary operation. However, under no circumstances should one connect the charger to the battery pack. Batteries may gas or explode.

1. Be sure charger plug is removed from case before removal of battery compartment.

Remove Battery Pack by sliding two finger buttons down away from center of case. This unlocks battery pack and permits removal.

2. Remove two screws and separate two halves of battery pack.
3. Install 4 AA Ni. Cad. Cells as shown observing polarity and reassemble.



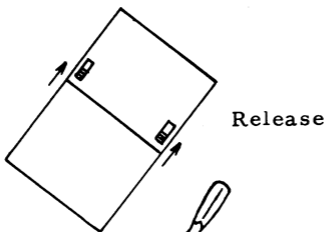

Release

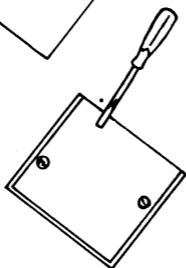

Remove  
2 Screws

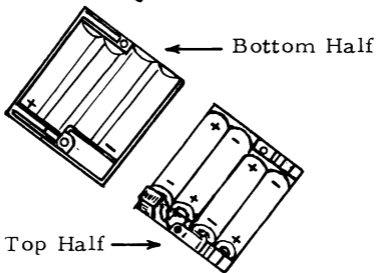

Bottom Half

Top Half

## GENERAL INSTRUCTIONS

### START WITH HIGHEST RANGE

When the approximate value of the voltage or current being measured is not known, always start with the highest range to avoid overload and blowing a fuse.

### RANGE CHOICE

For greatest accuracy choose the range which utilizes the largest number of digits to give greatest resolution.

### DO NOT CHANGE SWITCHES UNDER LOAD

A quality switch is used but any switch will arc if changed while under load. Disconnect the test probes or shut off the circuit under test before the range switch or AC-DC switch positions are changed. This practice will result in increased life and reliability of the instrument.

### MEASUREMENT ERRORS

Readings on the sensitive ranges may sometimes be different than expected due to thermoelectric or electrochemical effects.

Readings on the high resistance ranges can be affected by touching the circuit causing the body to act as a shunting resistor.

Consideration should be given to the loading effect of the instrument when measuring voltages from sources of high impedance.

## PROBE ASSEMBLY

The probe is equipped with an ON and OFF switch. It has two operating modes.

1. Momentary "on": This is actuated by pushing spring loaded button on probe body forward. When released the tester will turn off. This operating mode is recommended for most measurements since current drain from batteries is kept at a minimum.
2. Lock "on": This is actuated by pushing button forward and rotating locking ring in the direction of the arrow on ring. To release, rotate locking ring in the opposite direction. The button will spring back to the off position.
3. Lock "off": With the push but-

## 18 GENERAL INSTRUCTIONS (cont'd.)

ton resting back in the normal off position, rotate locking ring in the direction of arrow. To release lock for momentary operation rotate in the opposite direction.

### INSTALLING PROBE IN TESTER

The probe plug is polarized. Carefully note prong spacing on plug and tester, insert plug into tester with prong spacing oriented with tester.

Push down on plug until the lock mechanism is engaged.

To remove plug from tester merely depress button on body of plug and pull out.

## BATTERY TEST

Insert probe assembly plug end into top of tester, making sure plug is firmly seated with latch on plug engaged.

1. Set AC-DC  $\Omega$  function selector to DC  $\Omega$  position.
2. Set range selector to 20 V.
3. Attach alligator clip to probe tip.

Caution - Alligator clip must be attached to probe tip to prevent naked probe tip from shorting across charger jack which would cause severe arcing.

4. Press "push to operate" button on probe to energize tester.
5. Touch probe tip with alligator clip on, to center terminal of charger jack.
6. Voltage reading should be in the range of 4.40 to 5.8 V. Voltages near 4.4 V indicate batteries require recharge and voltages near 5.8 V indicate full batteries.

## AUTOMATIC INDICATION OF LOW BATTERIES

The Model 3000 is designed to warn the user when the batteries are low and require recharging.

When the battery voltage drops to 4.4 Volts, all decimal points (one for each digit) turn on.

This indicates that the batteries are low and the measurements made with the tester may be in error and cannot be relied on.

Batteries causing this indication should be recharged.

## BATTERY LIFE

Battery life is a function of how the tester is used. If the tester is locked "on" for continuous battery drain, fully charged Nickel Cadmium batteries will last approximately 2 to 3 hours, before recharging is required.

If the momentary "on" mode is used, then battery life increases considerably.

If short "on" cycles are used, several thousand measurements can be made before batteries are discharged.

Battery Charging - When batteries require recharging, the charger plug is inserted into the top right side of tester. The line cord plug is plugged

into a 115 VAC receptacle. The batteries should be fully charged in approximately 3 1/2 hours.

The Model 3000 may also be operated to make measurements while the charger is connected.

The charger will supply enough voltage to operate the tester even though its batteries are discharged, however, the batteries will not be charged under the above conditions. To charge the batteries the tester must be turned off.

It is therefore recommended that the momentary "on" mode operation be used when the tester is used on the bench with the charger connected. In this way the user is always assured that the batteries are always fully charged for use without charger.

## 22 OPERATING INSTRUCTIONS (cont'd.)

### MEASURING AC OR DC VOLTS

1. Insert probe assembly plug into tester.
2. Set AC-DC  $\Omega$  switch to either AC or DC position.
3. Set range selector to desired range. If desired range is unknown, set to highest range (600 V).
4. Connect common test lead and probe tip across voltage to be measured observing all safety precautions.
5. Push button on probe body forward and observe reading in window of tester. If reading is less than 199 remove probe from voltage under test and switch range selector to a lower range. Reconnect probe to voltage and push button for another higher resolution reading.

Note - If a blinking reading is observed, the tester is overranged. The voltage applied is higher than range setting, thus the range selector should be switched to a higher range.



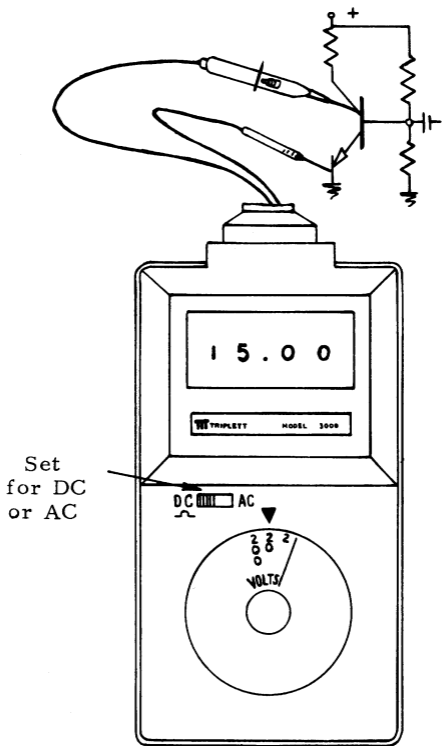

Measuring AC or DC Volts

## 24 OPERATING INSTRUCTIONS (cont'd.)

### MEASURING RESISTANCE

1. Plug probe assembly into tester.
2. Set AC-DC  $\Omega$  switch to DC  $\Omega$  position.
3. Set range selector to desired range.
4. Connect common test lead and probe tip to resistor under test.
5. Push button on probe body forward and observe reading in window of tester. If reading is less than 199 switch range selector to lower range for a greater resolution reading. If a blinking reading is observed, switch the range selector to a higher range until a higher resolution reading is obtained.

Note - It should be noted that of the 6 ohms ranges employed, 3 are low voltage ohms, green numerals (200 mV across resistor under test for FS reading) and 3 are high voltage ohms, black numerals (2 V across resistor for FS reading). The low and high voltage ohms ranges are alternated starting with Lo at 200  $\Omega$  and ending in Hi at 20 M. The range, voltages and currents are given in the Specifications Section, page 10.

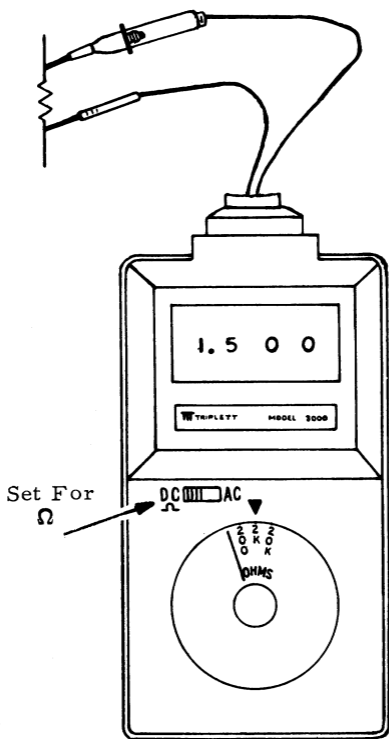

Measuring Resistance

Note - The 200  $\Omega$  range has a sensitivity of .1  $\Omega$ . With the leads shorted the tester will read the fuse and lead resistance. This reading should be subtracted from the reading of the resistor under test.

## MEASURING DIODES OR JUNCTIONS

If diode or junction tests are to be made, the Hi V ohms ranges are to be used. If Lo V ohms ranges are used, an overrange indication will result in either polarity.

When using Hi V ohms ranges to make diode tests in the forward direction, connect red test probe to anode, black to cathode. A resistance reading will be observed if diode is not open.

When the 2 K range is used, the forward resistance reading is actually the forward voltage drop across the diode with one milliamperere flowing thru it.

This is a standard test which conforms to handbook conditions.

When leads are reversed (reverse direction) an overrange indication will be observed if diode is not shorted.

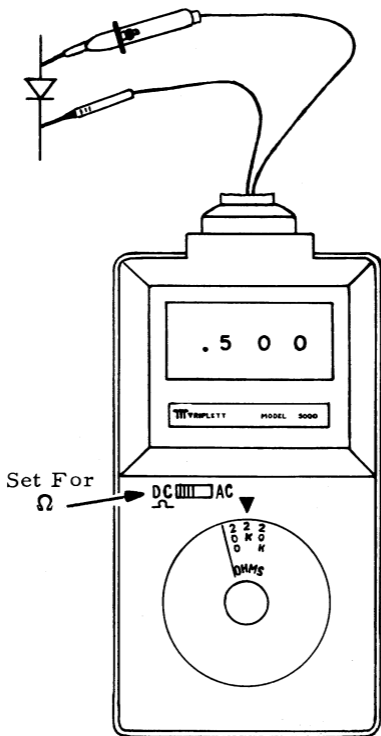

Measuring Diodes or Junctions

Under normal circumstances maintenance and calibration are not required. It is recommended that any calibration or maintenance other than fuse replacement be performed by an authorized factory repair center.

### FUSE REPLACEMENT

There are 2 fuses used in the Triplet Model 3000. They are both located in the probe assembly and can be removed by unscrewing front half of probe body which separates directly in front of locking ring.

The fuse closest to the front of the probe is a 2 amp 600V fuse, Bussmann BBS-2 (Triplet P/N 3207-61) and will not normally blow unless the unit has been subjected to extreme high voltage overload conditions.

The fuse located near the rear of the probe is a 1 amp 250V fuse, Littelfuse 362001 (Triplet P/N 3207-43).

### CALIBRATION

It is recommended that the unit be returned to the factory for calibration because the precision voltage, current, and resistance standards required are

not normally available at most maintenance facilities.

If recalibration is required, the following equipment is needed.

1. DC Voltage Standard - with DC Voltage Output from 100 mV to 600 V  $\pm .05\%$  accuracy.
2. AC Voltage Standard - with AC Voltage Output from 100 mV RMS to 600 V RMS  $\pm .05\%$  accuracy.
3. Resistance Standard 100  $\Omega$ , 1,000  $\Omega$ , 10 K $\Omega$ , 100 K $\Omega$ , 1 Meg.  $\Omega$ , 10 Meg.  $\Omega$   $\pm .1\%$  accuracy.
4. DC Current Standard 1 mA, 10 mA, 100 mA DC Output  $\pm .1\%$  accuracy.

Before calibrating make a Performance Check by using Table 1 and the appropriate test equipment.

## PERFORMANCE TABLE

DC		
RANGE	INPUT	READING
200 mV DC	100 mV	99.6-100.4
2 V DC	1 V	.989-1.011
20 V DC	10 V	9.89-10.11
200 V DC	100 V	98.9-101.1
600 V DC	600 V	594-606

## AC - At 60 Hz RMS

200 mV AC	100 mV	99.3-100.7
2 V AC	1 V	.984-1.016
20 V AC	10 V	9.84-10.16
200 V AC	100 V	98.4-101.6
600 V AC	600 V	592-608

## OHMS

200 $\Omega$	100 $\Omega$	98.9-101.1
2 K $\Omega$	1000 $\Omega$	.984-1.016
20 K $\Omega$	10 K $\Omega$	9.89-10.11
200 K $\Omega$	100 K $\Omega$	98.4-101.6
2 Meg $\Omega$	1 Meg $\Omega$	.989-1.011
20 Meg $\Omega$	10 Meg $\Omega$	9.84-10.16

## CURRENT

2 mA DC	1 mA DC	.986-1.014
20 mA DC	10 mA DC	9.86-10.14
200 mA DC	100 mA DC	98.6-101.4

Table 1



1. Inspection: Visually check for damaged parts.

Check fuses for continuity.

2. Power Supplies: Refer to Fig. 3 for Test Points.

Check +5 (TP1), +12, (TP2) and -12 (TP3) power supplies for proper voltage, TP1 should be +5.0V  $\pm$ .6V; TP2 and TP3 should be 12V  $\pm$ 2.5V.

If voltage is not present at TP2 and TP3 check for a 2.5V 25 kHz,  $\pm$ 5 kHz square wave at TP4 (Inverter Drive).

If TP4 is OK but TP1 and TP2 are not proper, check Q1 and Q2.

3. With the unit set to 20V DC, connect the probe to a 10 volt DC source and check TP5 (Input) for 10V. Check TP6 for 100 mV DC.

If TP5 is OK but TP6 is not, check range switch.

If TP6 is OK and unit does not function the module is probably bad.

4. Set the AC-DC switch to AC. Connect the probe to a signal genera-

34 TROUBLESHOOTING PROCEDURE  
(cont'd.)

tor and set the output to 10V RMS. TP5 should read 10V RMS. TP6 should read 100 mV DC. TP7 (AC - In) should read 100 mV RMS.

If TP6 is OK and unit does not function the module is bad.

5. Set the range switch to 200  $\Omega$  FS and the AC-DC switch to DC. Short the test leads together and measure TP5. TP5 should be 0V DC.

Open the test leads and check TP5. TP5 should be +12V  $\pm$ 2.5V and the display should blink indicating overrange.

Connect the test leads to a 100  $\Omega$  resistor. TP5, TP6 and TP8 ( $\Omega$ 's Input) should all read 100 mV DC.

If TP5, TP6 and TP8 do not read the same voltage check the range switch and switch wiring.

If TP5, TP6 and TP8 are OK but unit does not function the module is bad.

6. Set the range switch to the 1 mA range with a current of 1 mA flowing into the test leads. TP5 and TP6 should read 100 mV DC.

## DISASSEMBLY PROCEDURE FOR CALIBRATION

35

Remove the knob cap, knob screw, knob washer and function knob. (See Fig. 2).

Important: Remember the knob position. You will need to know its position since the index and stop are on the top case half.

While holding the front and back case halves together remove the 4 case holding screws. (See Fig. 2).

Carefully remove the front case half while leaving the printed circuit boards, knob shaft and rotor in the back half of the case.

Tape bottom and top printed circuit board down to provide proper pressure on switch index.

Slip the function knob back on the shaft.

Be careful when turning the knob not to turn too far in either direction since the switch stop is on the top case.

### DC CALIBRATION

Set zero, if necessary see page 36.

Set the unit to 200 mV full scale with a input of  $199.9 \text{ mV} \pm .05\%$ . Adjust the DC full scale potentiometer (See Fig. 3) for a reading of 199.9.

Make a DC Performance Test using Table 1.

## AC CALIBRATION

Set the unit to the 200 mV AC range. With an input of 199.9 V RMS 60 Hz  $\pm$ .05% adjust the AC gain control (See Fig. 3) for a reading of 199.9.

Make an AC Performance Test using the AC Section of Table 1.

## OHMS CALIBRATION

Set the unit to the 20 K $\Omega$  position. While measuring a 10 K $\Omega$   $\pm$ .1% resistor adjust the ohms potentiometer (See Fig. 3) for a reading of 10.00.

Make an Ohms Performance Check using the Ohms Section of Table 1.

## CURRENT CALIBRATE

There is no adjustment for AC or DC current.

## ZERO ADJUST

Set range for 200 K $\Omega$  and function to DC $\Omega$ , short leads and adjust CZ for zero (See Fig. 3).

Set range to 200 mV and function to DC $\Omega$ . Short test leads and adjust R121 for zero.

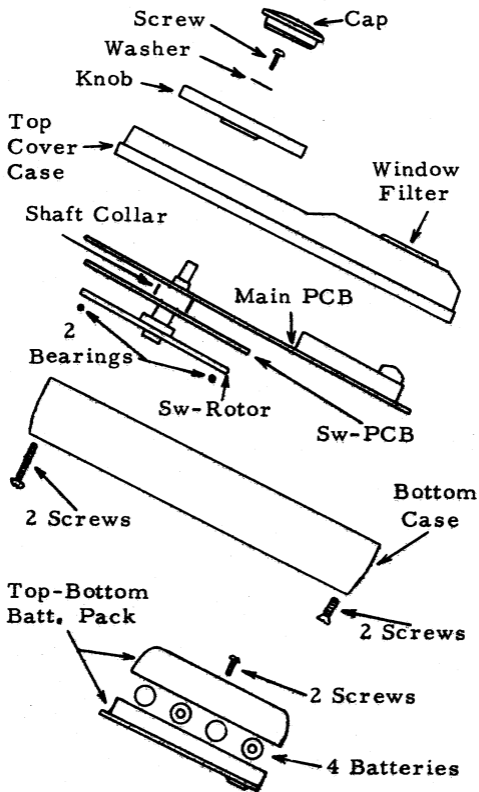

Exploded View Fig. 2

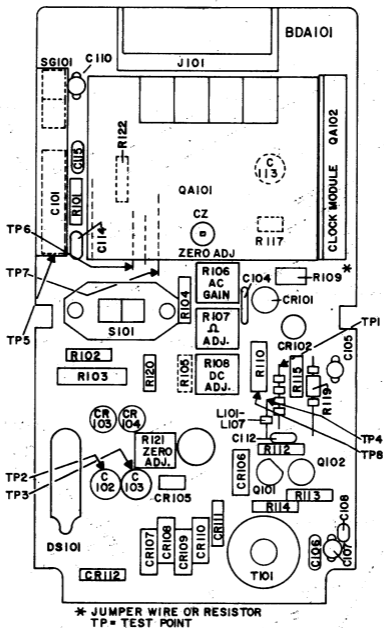

Main Board, Parts Location  
Fig. 3

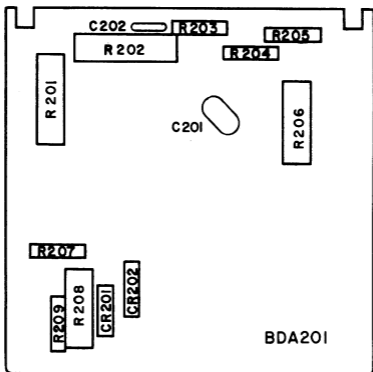

Switch Board, Parts Location  
Fig. 4

#### Replaceable Parts Model 3000

Description	Ref. No.	Part No.
PC Bd. Main		
Complete	BDA101	87-453
Hybrid Module	QA101	126-67
*Clock Module	QA102	126-69
Resistor		
*100K Prec.	R101	15-5698
1 $\Omega$ W. W.	R103	15-5696
*11.1K Prec.	R104	15-5697
*75K Prec.	R105	15K-7502WA3
1K Var.	R106, 7	16-265

\*Resistors and QA102 may be in the Hybrid Module.

## 40 Replaceable Parts Model 3000 (cont'd.)

Description	Ref. No.	Part No.
5K Var.	R108	16-266
50K Var.	R121	16-280
Capacitor		
.022 $\mu$ F 400V	C101	43-462
22 $\mu$ F 15V	C102, 3	43-411
82 pF 1000V	C104	43-433
47 $\mu$ F 6V	C105, 7, 10	43-399
.1 $\mu$ F 15V	C106	43-459
.0022 $\mu$ F 100V	C108	43-360
.1 $\mu$ F 15V	C112	43-459
.01 $\mu$ F 100V	C113	43-363
.047 $\mu$ F 100V	C114	43-361
.1 $\mu$ F 100V	C115	43-445
Lamp, Neon	DS101	67-98
Diode	CR101, 2	127-122
Diode	CR103, 4	127-121
Diode	CR105	127-65 or
1N4002	Thru 110	127-93
Diode, Zener		
1N4745	CR111, 112	127-123
Transistor		
2N5134	Q101	127-60
Transistor		
2N4013	Q102	127-120
Spark Gap		
1.5 KV	SG101	12388
Transformer		
	T101	23-219



# Replaceable Parts Model 3000 (cont'd.) 41

Description	Ref. No.	Part No.
Suppressor Ferrite	L101 Thru 107	11177
Battery Charger		12385
PC Bd. Switch Complete	BDA201	87-455
Resistor		
4.5 Meg. 1/2W	R201, 2	15-5700
900K Prec.	R203	15K-9003UA3
90K Prec.	R204	15K-9002UA3
9K Prec.	R205	15K-9001UA3
1K W. W.	R206	15-5699
10 $\Omega$ Prec.	R207	15K-100FTA3
1 $\Omega$ W. W.	R208	15-5696
100 $\Omega$ Prec.	R209	15K-1000TA3
Diode		127-65 or
1N4002	CR201, 2	127-93
Capacitor		
180 pF 1000V	C201	43-383
20 pF 1000V	C202	43-436
Test Lead and Hdwe Package		79-385
Fuse, 1 Amp	F1	3207-43
250V Littelfuse		362001
Fuse, 2 Amp	F2	3207-61
600V Bussmann		BBS-2

## 42 Replaceable Parts Model 3000 (cont'd.)

Description	Ref. No.	Part No.
Case, Top Tester		10-2862
Case, Bottom Tester		10-2863
Bumper Foot		3236-16
Switch, Rotary	S1	22-696
Ball, Detent		11935
Knob, Rotary Switch		34-168
Case, Battery Complete		10-2861
Case, Top Battery		10-2865
Jack, Charger		33-74
Battery	B1	
Ni. Cad. "AA" Thru B4		37-49
Case, Bottom Battery		10-2866
Latch, Slide		12382
Instruction Manual		84-293

# CIRCUIT DIAGRAM

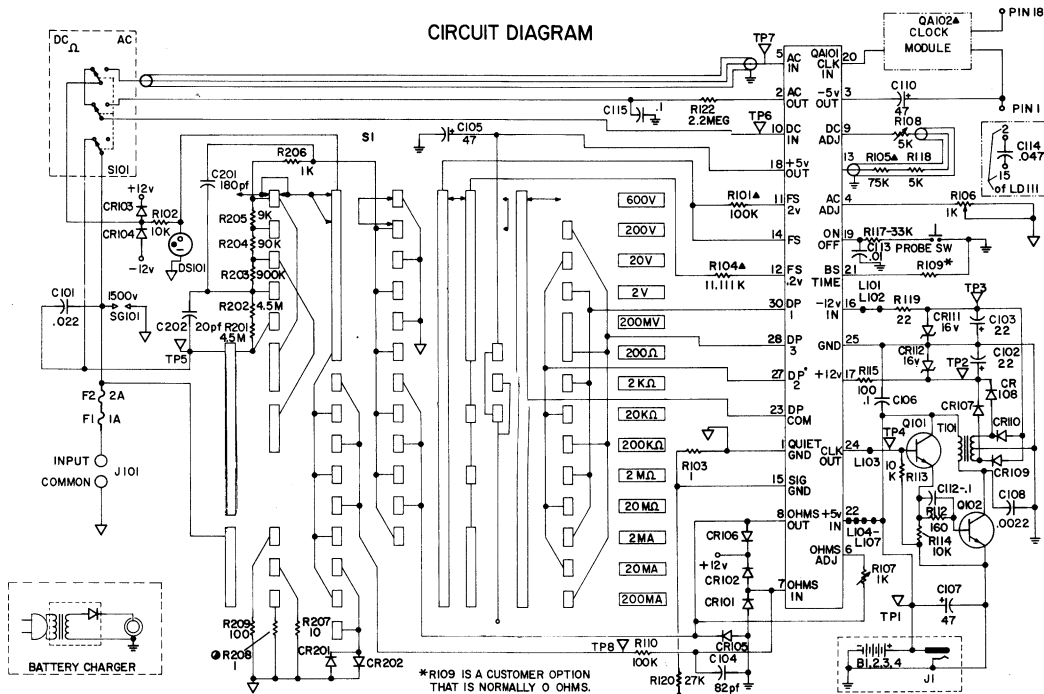

● R208A 68ohm parallels R208

\*R109 IS A CUSTOMER OPTION THAT IS NORMALLY 0 OHMS.

ALL CAPACITANCE IN MICROFARADS +12V -12V UNLESS OTHERWISE NOTED.

▲ RESISTORS @ CLOCK MODULE MAY BE IN HYBRID MODULE.

The Triplett Corporation warrants instruments and test equipment manufactured by it to be free from defective material or factory workmanship and agrees to repair or replace such products which, under normal use and service, disclose the defect to be the fault of our manufacturing, with no charge for parts and service. If we are unable to repair or replace the product, we will make a refund of the purchase price. Consult the Instruction Manual for instructions regarding the proper use and servicing of instruments and test equipment. Our obligation under this warranty is limited to repairing, replacing or making refund on any instrument or test equipment which proves to be defective within one year from the date of original purchase.

This warranty does not apply to any of our products which have been repaired or altered by unauthorized persons in any way so as, in our sole judgment, to injure their stability or reliability, or which have been subject to misuse, abuse, misapplication, negligence or accident or which have had the serial numbers altered, defaced, or removed. Accessories, including batteries, not of our manufacture used with this product are not covered by this warranty.

To register a claim under the provisions of this warranty, return the instrument or test equipment to Triplett Corporation, Bluffton, Ohio 45817, transportation prepaid. Upon our inspection of the product, we will advise you as to the disposition of your claim.

**LIMITED WARRANTY (Cont.)**

**ALL WARRANTIES IMPLIED BY LAW ARE HEREBY LIMITED TO A PERIOD OF ONE YEAR, AND THE PROVISIONS OF THE WARRANTY ARE EXPRESSLY IN LIEU OF ANY OTHER WARRANTIES EXPRESSED OR IMPLIED.**

The purchaser agrees to assume all liability for any damages and bodily injury which may result from the use or misuse of the product by the purchaser, his employees, or others, and the remedies provided for in this warranty are expressly in lieu of any other liability Triplett Corporation may have, including incidental or consequential damages.

Some states do not allow the exclusion or limitation of incidental or consequential damages, so the above limitation or exclusion may not apply to you. No representative of Triplett Corporation or any other person is authorized to extend the liability of Triplett Corporation in connection with the sale of its products beyond the terms hereof.

Triplett Corporation reserves the right to discontinue models at any time, or change specifications, price or design, without notice and without incurring any obligation.

This warranty gives you specific legal rights, and you may have other rights which vary from state to state.

**TRIPLETT CORPORATION  
Bluffton, Ohio 45817**

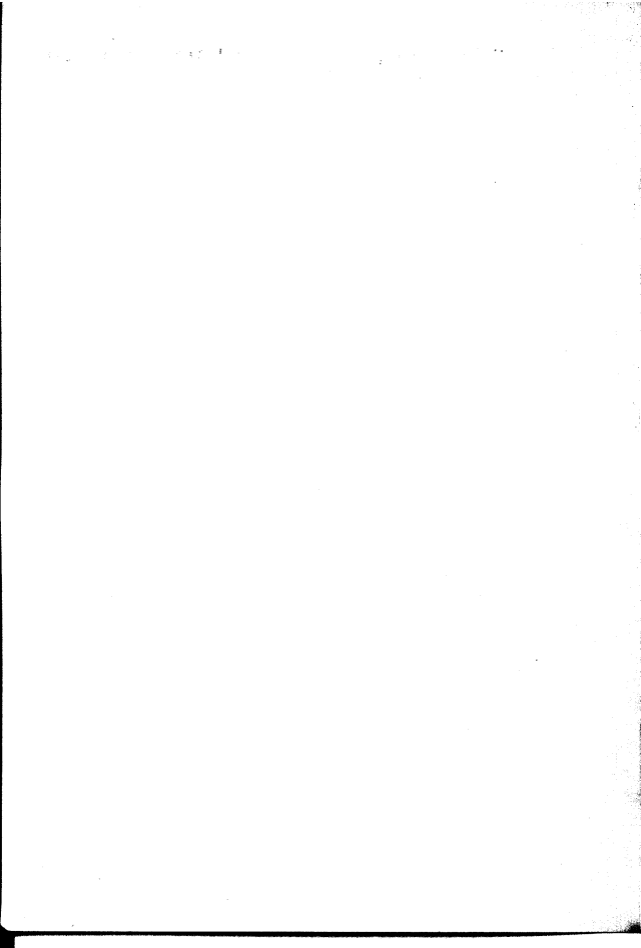

Triplett Corporation

Bluffton, Ohio 45817